



Product Catalogue 2023



Symbols



EHS (Ergonomic Handling System)
System adopted for the controls of several power tools, to ensure easy use, reduced fatigue, and the utmost simplification for users.



Gasoline
Gasoline fuel type engine.



Diesel
Diesel fuel type engine.



Original accessories and spare parts
Quality mark identifying original Emak parts and accessories. Designed to the most stringent quality standards, these items guarantee smoother operation of the machine and longer service life.

Contents

	Corporate setup	4	
	Rotary tillers	8	
	Two wheel tractors	20	
	Flail mowers	56	
	Cutterbar mowers	64	
	Transporters	106	
	Boots, Lubricants and sundry Accessories	118	
	Emak Engines Agriculture Line	126	
	Emak Engines Gardening Line	134	



The Emak Group

Our Vision

"Innovative solutions for the best customer value"

We aim to operate as one of the world's foremost players in the development, production and distribution of machines, components and accessories for gardening, agriculture, forestry and industry, with an offering of innovative products and services designed to make the work of our clients in the consumer and professional markets efficient and enjoyable, guaranteeing that they always receive the highest possible value.



Structure

The **Emak Group** is active in the development, production and worldwide sale of an extensive range of products for three business segments:

Outdoor Power Equipment

- products for gardening, forestry and agriculture, including brushcutters, lawnmowers, garden tractors, chainsaws, rotary tillers and rotary cultivators.

Pumps and High Pressure Water Jetting

- products for agriculture, including centrifugal and diaphragm pumps for crop spraying and weed control;
- products for industry, including pumps for industrial applications and high and very-high pressure systems;
- products for cleaning, namely professional and semiprofessional high-pressure washers, floor scrubber-dryers and vacuum sweepers.

Components and Accessories

- products such as trimmer line and line heads for brushcutters, accessories for chainsaws, guns, valves and nozzles for high-pressure washers and for agricultural applications, plus precision farming products (sensors and computers).

The group has approximately **2,000 employees** overall.



The Emak Group

Divisions and Product Range

Outdoor Power Equipment

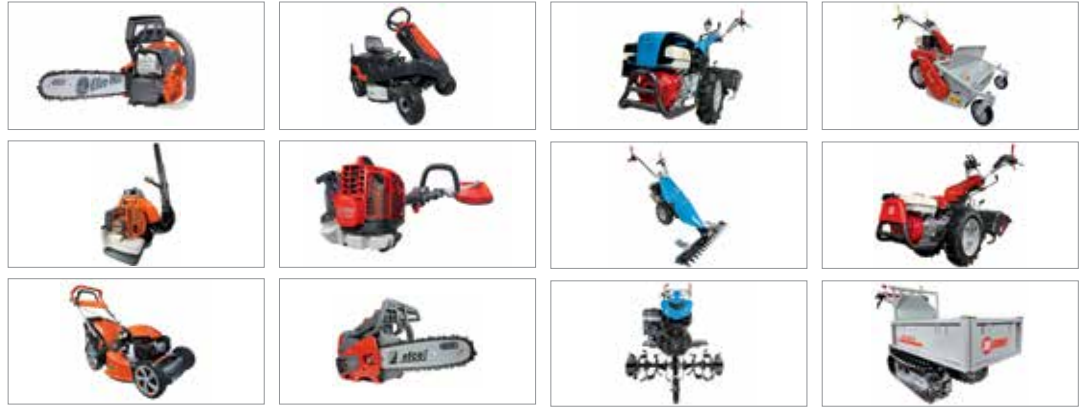

Pumps and High Pressure Water Jetting



Components and Accessories

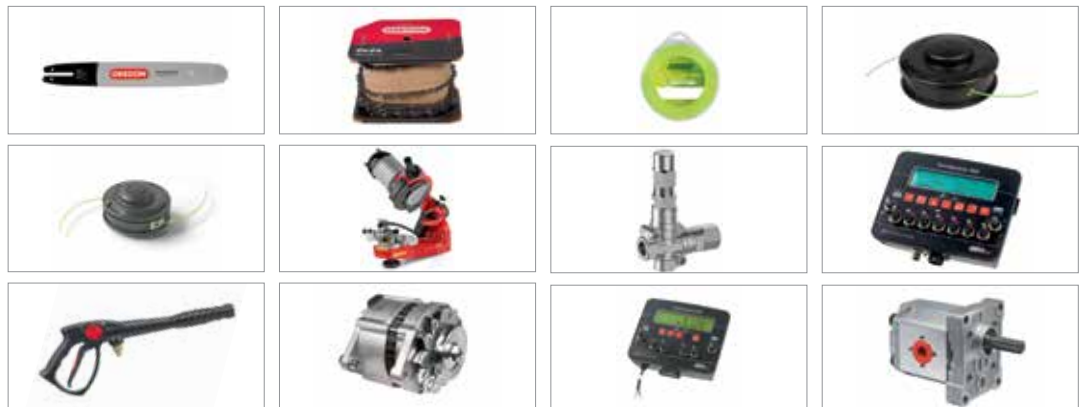

Outdoor Power Equipment

Our Passion

Emak's green ethos is made up of certainty, innovation and completeness. Our green credentials are based on care, respect, passion and design focus. That's why, with our **Efco**, **Oleo-Mac**, **Bertolini** and **Nibbi** brands, **Emak** stands as a benchmark in groundcare and garden maintenance for professionals and amateurs alike. A passion that has been all-Italian for more than 50 years. There's an **Emak** for everyone.



Structure

Emak operates in the **Outdoor Power Equipment** segment through **9** companies engaged in the development, production and sale of products for gardening and forestry, and small agricultural machines, including brushcutters, lawnmowers, garden tractors, chainsaws, rotary tillers and rotary cultivators.

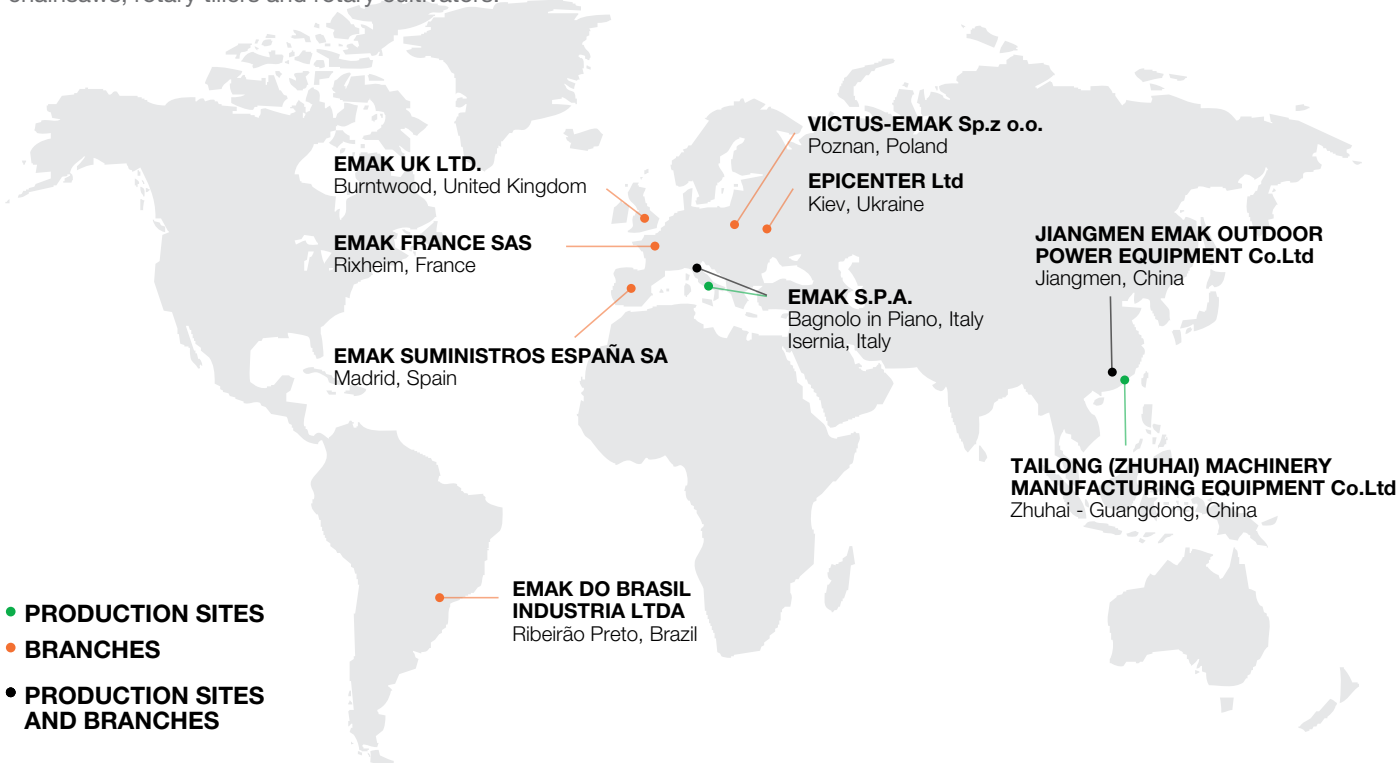

Facts and Figures

4	brands
4	production units
8	countries with direct presence
~800	personnel
170	dealers nationwide
115	countries served
22	product families
250	models



Outdoor Power Equipment

Products and Accessories Range

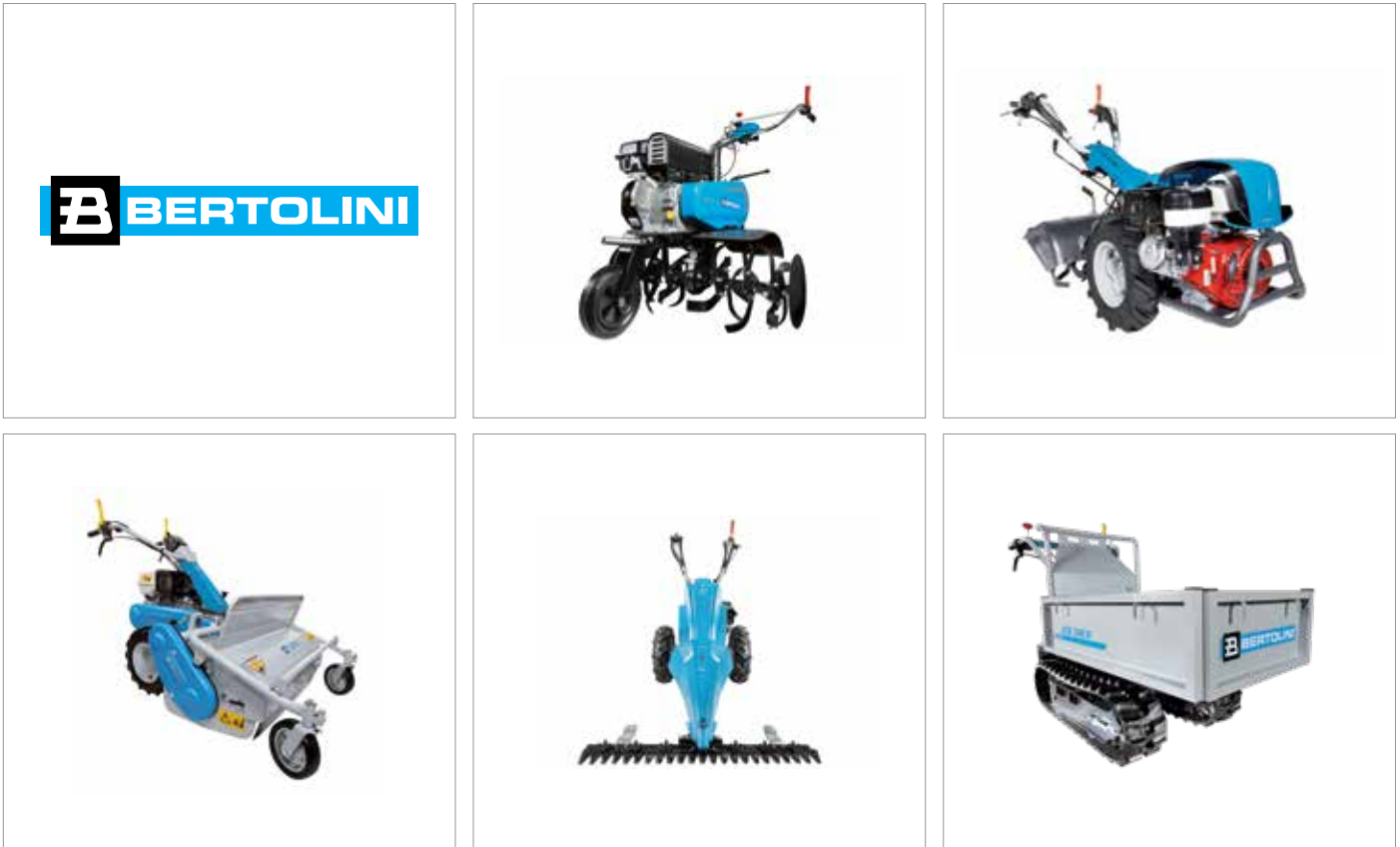

A thorough-going process of product development implemented by **Bertolini** has resulted in a **truly comprehensive, constantly updated range of machines, suitable for agriculture ground care and maintenance of allotments and gardens** and capable of responding to the needs of users at every level. Products differ according to the use for which they are designed, but all feature the same high standards of quality in terms of performance, reliability, comfort and safety.

Home-plus



Home-plus

A range of machines aimed at the home user, for tidying and cleaning the garden, cutting hedges and small trunks or stems, and DIY jobs in general. Characterized by lightweight and compact construction, to make the task of the operator that much simpler. Easy to start, easy to use, easy to maintain: these are the ideal tools for getting things done quickly and neatly around the home.

Tough-tech



Tough-tech

Solid and dependable, these are machines designed for heavy and frequent use in countryside environments: clearing overgrown and uncultivated areas, pruning and cutting firewood, crop irrigation and disinfection tasks. Designed adopting solutions certain to ensure high work rates and maximum durability over time.

Sharp-pro



Sharp-pro

No-nonsense everyday tools for the busy professional, these are machines that stand out for the toughness of their components, their high performance and their matchless long-term durability. Specific materials used in construction guarantee unwavering quality even when tackling the most severe and lengthy of tasks, like forestry work and the clearance of uncultivated areas or scrub and undergrowth.

Specialist machines for soil preparation. Powerful and sturdy over large areas, practical and reliable even in private gardens and allotments: a wide range to suit all needs.

HOME



INTENSIVE



PROFESSIONAL



155



2.4 46

205 S



5.7 85

215 S



4.8-6.7 87

195 S



5.7 82

218



6.7-7.0 100

TECHNICAL DATA



gearbox

power

rotor





Rotary tillers

Rotary tiller for home use

155



Ideal for home gardeners who need to prepare vegetable patches and flower beds for seeding, this model offers an excellent combination of manageability and user-friendliness.



Rear wheel for easy transportation of the machine.



Speed regulator with integrated on-off system and control lever located within easy reach.



46 cm rotor with three elements per side, can be reduced to 32-22 cm.

155

Power supply	Engine	Model	Displacement	Power	Starting	Code
gasoline	Emak	K 300 H OHV	80 cm ³	2.4 HP	recoil start	68569001E5

Focus on accessories

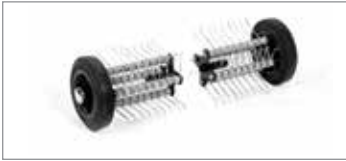

Scarifier
Code **69209018**



Gearbox:

1-speed (1 forward)

Rotor speed with engine at 3400 rpm

159

Dimensions (mm)

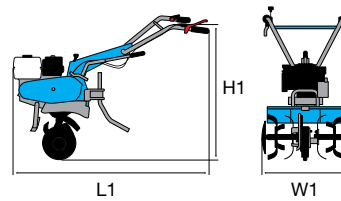

L1	1150
H1	1000
W1	460-320-220

Transmission	chain
Clutch	belt with tensioner
Handlebars	3 vertical adjustment positions
Rotor	46 cm, can be reduced to 32-22 cm
Power take-off	no
Spur	yes
Towing hitch	no
Transport wheel	yes
Weight	27 kg

Rotary tiller for home use

195 S



Ideal for home gardeners who need to soften up the soil for seeding, this model offers an excellent combination of manageability and user-friendliness.



Front wheel for easy transportation of the machine. The wheel can be easily folded upward without tools to facilitate operations on the ground.

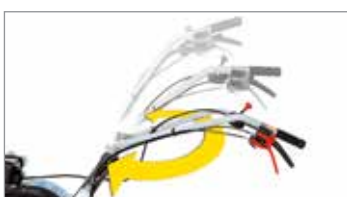

Handlebars with horizontal and vertical adjustment to allow the operator to assume the correct posture while working.







82 cm rotor with three elements per side with lateral protection discs.

195 S

Power supply	Engine	Model	Displacement	Power	Starting	Code
gasoline	Emak	K 800 HT OHV	182 cm ³	5.7 HP	recoil start	68599001E5A

Focus on accessories

	Furrowing tool Code 69209081 (requires tool holder 69209087)
	Plough Code 69209082 (requires tool holder 69209087)
	Potato digger Code 69209083 (requires tool holder 69209087)
	Tool holder Code 69209087
	Pair of metal wheels Code 69209084



Gearbox:

2-speed (1 forward + 1 reverse)

Rotor speed with engine at 3400 rpm

159 **1** **1R** 66

Dimensions (mm)

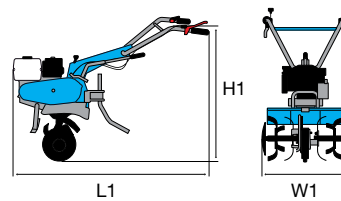

L1	1400
H1	800
W1	820-550

Transmission	chain
Clutch	belt with tensioner
Handlebars	with vertical and horizontal adjustment
Rotor	82 cm, can be reduced to 55-35 cm, with lateral protection discs
Power take-off	no
Spur	yes
Towing hitch	yes
Transport wheel	yes
Weight	57 kg

Rotary tiller for intensive use

205 S



Ideal for demanding home gardeners to prepare the soil for sowing. This model features two forward speeds and one reverse, the perfect combination for the most difficult jobs.



Practical and ergonomic external gear selector. Integrated tool holder and depth adjustable jackleg.



Handlebars with vertical and horizontal adjustment by means of an easily accessible lever, allowing the operator to assume the correct posture for the maximum working comfort.









85 cm rotor (reducible to 60-35 cm), oversized knives and lateral protection discs.

205 S

Power supply	Engine	Model	Displacement	Power	Starting	Code
gasoline	Emak	K 800 HC OHV	182 cm ³	5.7 HP	recoil start	68589010E5

Focus on accessories

	Furrowing tool Code 69209081
	Plough Code 69209082
	Potato digger Code 69209083
	Pair of metal wheels Code 69209116
	Pair of tyred wheels 3.50-6\" Code 69209089
	Pair of tyred wheels 3.50-8\" Code 69209114



Gearbox:

3-speed (2 forward + 1 reverse)

Rotor speed with engine at 3400 rpm

83	1	1R	62
114	2		

Dimensions (mm)

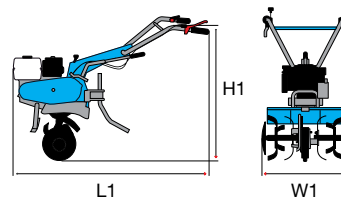

L1	1630
H1	1050
W1	850-600-350

Transmission	with oil-bath gearbox and chain
Clutch	belt with tensioner
Handlebars	with vertical and horizontal adjustment
Rotor	85 cm, reducible to 60-35 cm, with side protection discs
Power take-off	no
Spur	yes, depth adjustable
Towing hitch	yes, with integral tool holder
Transport wheel	yes
Weight	63 kg

Professional rotary tiller

215 S



Extremely reliable, compact and easy to handle. Designed to meet the needs of smallholders and groundcare professionals. The direct gear transmission and multi-disc clutch make the machine extremely resistant to the stresses generated during work operations while maximising operator comfort.



Direct transmission with gears on the crankshaft for the maximum stress resistance.



Versatile, thanks to the 3-speed gearbox (2 forward + 1 reverse) that makes it possible to achieve the same tillage results irrespective of the hardness and consistency of the soil.



Extremely rugged oil-bath gearbox with very low maintenance requirements.

215 S

Power supply	Engine	Model	Displacement	Power	Starting	Code
gasoline	POWERED BY HONDA	GX 160 OHV	163 cm ³	4.8 HP	recoil start	68649020E5A
gasoline	POWERED BY HONDA	GX 200 OHV	196 cm ³	5.8 HP	recoil start	68649051E5A
gasoline	Emak	K 800 H OHV	182 cm ³	5.7 HP	recoil start	68649034E5A
diesel	Emak	K 7000 HD	349 cm ³	6.7 HP	recoil start	68649049E5A

Focus on accessories

	Pair of lateral transport wheels Ø 420 mm Code 68600001
	Adjustable furrower Code 68600006
	Flange for wheels Code L0093800
	Pair of tyred wheels 4.00-8" Fixed disc Code 69209025B (requires hubs L0093800)
	Pair of steel wheels Ø 410x60 mm Code L0756011 (requires hubs L0093800)
	Pair of metal wheels Ø 410x60 mm With width adjustment rings Code 68242001 (requires wheel flange L0093800)



Gearbox:

3-speed (2 forward + 1 reverse)

Rotor speed with engine at 3600 rpm

87	1	1R	48
147	2		

Dimensions (mm)

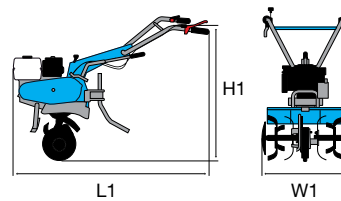

L1	1350
H1	800
W1	870-600

Transmission	oil-bath gearbox
Clutch	wet multi-disc
Handlebars	with vertical and horizontal adjustment
Rotor	87 cm, reducible to 60 cm, with side protection discs
Power take-off	yes, independent 2100 rpm
Spur	yes
Towing hitch	yes
Transport wheel	yes
Weight	80 kg with petrol engine – 90 kg with diesel engine

Professional rotary tiller

218



Model designed to meet the needs of smallholders and groundcare professionals. The direct gear transmission on the crankshaft makes the tool resistant to the stresses generated when working on hard terrain.



Direct gear transmission on the crankshaft with oil-immersed multi-disc clutch.



Extreme versatility thanks to the 4-speed gearbox (3 forward + 1 reverse) that makes it possible to achieve the same tillage results irrespective of the hardness and consistency of the soil.

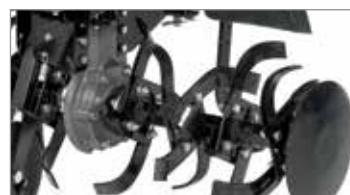





Oil-bath gear drive, extremely robust and with reduced maintenance requirements.

218

Power supply	Engine	Model	Displacement	Power	Starting	Code
gasoline	Emak	K 900 HR OHV	252 cm ³	7.0 HP	recoil start	68579001E5S1
diesel	Emak	K 7000 HDR	349 cm ³	6.7 HP	recoil start	68579002E5AS1

Focus on accessories

	Furrowing tool Code 69209081
	Plough Code 69209082
	Potato digger Code 69209083
	Pair of metal wheels Code 69209122
	Pair of tyred wheels 3.50-8" Code 69209123



Gearbox:

4-speed (3 forward + 1 reverse)

Rotor speed with engine at 3600 rpm

58	1	1R	44
102	2		
140	3		

Dimensions (mm)

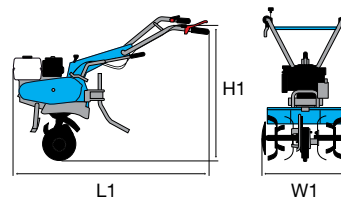

L1	1500 (gasoline) 1700 (diesel)
H1	1100
W1	1000-820-600

Transmission	with oil-bath gearbox
Clutch	wet multi-disc
Handlebars	with vertical and horizontal adjustment
Rotor	100 cm, reducible to 80-60 cm, with side protection discs
Power take-off	yes, 3600 rpm
Spur	yes, depth adjustable
Towing hitch	yes, with integral tool holder
Transport wheel	yes (diesel version with front stand)
Weight	96 kg with petrol engine – 131 kg with diesel engine

Powerful and reliable,
easy to handle, reversible and versatile,
these machines represent the ideal solution
for all ground jobs in any season.

HOME



400

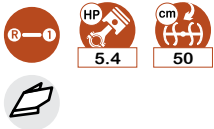

401 S



INTENSIVE



405 S



407 S



413 S



PROFESSIONAL



417 S



418 S



TECHNICAL DATA



OPTIONAL





Two wheel tractors

Two wheel tractor for home use

400



Ideal for home users with small gardens requiring periodic soil preparation for sowing, also in particularly difficult conditions. The rotor turns in the opposite direction to the direction of rotation of the wheels, thus giving the operator the maximum control of the cultivator and significantly reducing transmitted vibration levels.



50 cm wide counter-rotating rotor to facilitate work on particularly difficult terrain.



Large sized wheels for easier maneuvering of the machine.



Rotor depth adjustment enables operation on all types of terrain.

400

Power supply	Engine	Model	Displacement	Power	Starting	Code
gasoline	Emak	K 700 H OHV	182 cm ³	5.4 HP	recoil start	68369001E5

Focus on accessories



Rear-mounted furrowing tool
Code **69209111**



Pair of steel wheels Ø 370 mm
Code **L0051200**



WITH TWO WHEEL TRACTOR

Gearbox/ Speed (km/h):

2-speed (1 forward + 1 reverse) with 4.00-8" wheels

Speed (km/h)

1.45 **1** **1R** 2.64

Dimensions (mm)

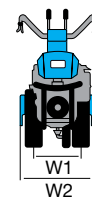
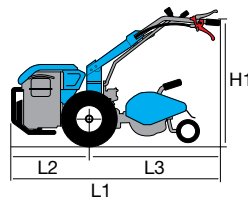

L1	1650
L2	540
L3	1110
H1	960
W1	430
W2	500

Transmission	with oil-bath gearbox
Clutch	direct engagement
Handlebars	with vertical adjustment
Reverse gear	no
Differential	no
Brakes	no
Power take-off	synchronised with forward travel
Accessories installation	no
Towing hitch	no
Cowling	no
Weight	75 kg (complete machine)

Two wheel tractor for home use

401 S



Designed for demanding home gardeners tending an allotment or vegetable plot, this two wheel tractor is extremely functional and offers the optimal combination of ease of use and safety.



Handlebar-mounted PTO control.



Handlebars with vertical and horizontal adjustment and 180° reversible, with vibration-damping device to assure more comfortable handling.



Integral QuickFit coupling that allows the operator to change the equipment without using tools.

401 S

Power supply	Engine	Model	Displacement	Power	Starting	Code
gasoline	POWERED BY HONDA	GX 160 OHV	163 cm ³	4.8 HP	recoil start	68319100E5
gasoline	Emak	K 800 H OHV	182 cm ³	5.7 HP	recoil start	68319102E5

Focus on accessories



Rotor Ø 280, 50-(35) cm
12 spikes
coupling for **Quickfit**
(can be reduced to 35 cm with kit **L0116300**)
Code **69219110**



Rear-mounted furrowing tool
Code **L0050600**



Brush L 80 - Ø 35 cm
With horizontal
and vertical adjustment
Code **L0070000**



WITH TWO WHEEL TRACTOR

Gearbox/ Speed (km/h):

2-speed (1 forward + 1 reverse) with 4.00-8" wheels



WITH CUTTERBAR MOWER

Gearbox/ Speed (km/h):

2-speed (1 forward + 1 reverse) with 4.00-8" wheels



Dimensions (mm)

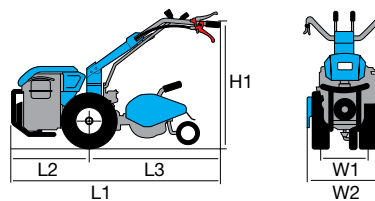

L1	1440
L2	470
L3	970
H1	230-1050
W1	380
W2	350-600

Dimensions (mm)

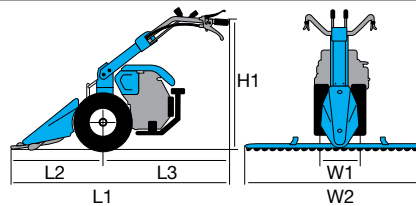









L1	1465
L2	600
L3	865
H1	345-1150
W1	380
W2	900-1117

Transmission	with oil-bath gearbox
Clutch	dry multidisc
Handlebars	with vertical and horizontal adjustment and 180° reversible, with vibration-damping device
Reverse gear	no
Differential	no
Brakes	no
Power take-off	independent 1004 rpm
Accessories installation	Integral QuickFit supplied as standard
Towing hitch	optional
Cowling	no
Weight	75 kg (with diesel engine, rotor and wheels)









Accessories

401 S

Accessory			Optional accessory		
Rotors					
	Rotor Ø 280, 50 -(35) cm 12 spikes coupling for Quickfit (can be reduced to 35 cm with kit L0116300)	69219110		Support wheel	Z0020368
				Rear-mounted furrowing tool	L0050600
	Rotor Ø 280, 60 -50-(35) cm 16 spikes coupling for Quickfit (can be reduced to 35 cm with kit L0116300)	69219107		Support wheel	Z0020368
				Rear-mounted furrowing tool	L0050600
Tyred wheels					
	Pair of tyred wheels 4.00x8" Fixed disc Quickfit coupling	69209020A		Pair of snow chains	L1055015
				Pair of spacers L 100 mm	69209096
Steel wheels					
	Pair of steel wheels Ø 370 mm	L0051200			



Accessories

Accessory			Optional accessory		
Towing hitch					
	Towing hitch	L0060900			
Adjustable tool holder					
	Adjustable tool holder (requires towing hitch L0060900)	L0103400		Single share plough	L0100000
				Furrowing tool	L0103200
Bar drive					
	Cam drive	69229091		0.92 m Complete central cutter plate Special teeth	69222011
Front brush					
	Brush L 80-Ø 35 cm With horizontal and vertical adjustment	L0070000			

Two wheel tractor for intensive use

405 S



Designed for small and medium-size plots, this machine very effectively combines professional level reliability and performance with extreme ease of handling, making it ideal for demanding home users and smallholders. The full range of accessories, including rotors, cutterbars, brushes and snowthrowers, are designed to meet the requirements of users seeking a multifunction machine that's both practical and safe.



Handlebars with vertical and horizontal adjustment and 180° reversible, with vibration-damping device to assure more comfortable handling.



The EHS system ensures ease of use, reduced effort and the maximum simplification for users.



Practical forward/reverse shuttle enables the operator to change quickly into reverse gear from any speed, making the machine easy to handle even with the rotor or other accessories mounted.



405 S

Power supply	Engine	Model	Displacement	Power	Starting	Notes	Code
gasoline	POWERED BY HONDA	GX 200 OHV	196 cm ³	5.8 HP	recoil start		68359007E5
gasoline	Emak	K 800 H OHV	182 cm ³	5.7 HP	recoil start		68359004E5
diesel	Emak	K 7000 HD	349 cm ³	6.7 HP	recoil start		68359016E5A
diesel	Emak	K 7000 HD	349 cm ³	6.7 HP	recoil start/ electric	battery supplied as standard	68359022E5

Focus on accessories



Rotor Ø 280, 60-50-(40) cm
16 spikes
Fixed coupling
(can be reduced to 40 cm with kit **69210259**)
Code **69219103**



Oil-immersed drive
Code **69229096A**



Front shovel L 100x40 cm
Quickfit coupling
With horizontal and vertical adjustment
(requires QuickFit **69212006**)
Code **69209065**



WITH TWO WHEEL TRACTOR

Gearbox/ Speed (km/h):

4-speed (2 forward + 2 reverse) with 4.00-8" wheels

Speed (km/h)	1.05	1	1R	1.11
	2.20	2	2R	2.32

Dimensions (mm)

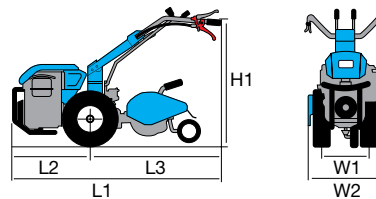

L1	1740
L2	550
L3	1190
H1	1250-300
W1	370
W2	600-400

WITH CUTTERBAR MOWER

Gearbox/ Speed (km/h):

4-speed (2 forward + 2 reverse) with 4.00-8" wheels

Speed (km/h)	1.11	1	1R	1.05
	2.32	2	2R	2.20

Dimensions (mm)

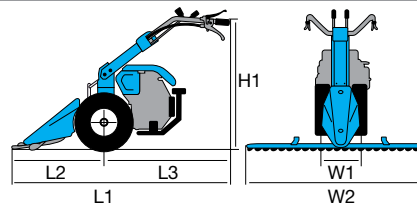

L1	1670
L2	900
L3	770
H1	1250-300
W1	370
W2	1270-950

Transmission	with oil-bath gearbox
Clutch	dry multidisc
Handlebars	with vertical and horizontal adjustment and 180° reversible, with vibration-damping device
Reverse gear	yes, with handlebar lever
Differential	no
Brakes	no (yes, only in diesel engine version)
Power take-off	independent 973 rpm
Accessories installation	QuickFit (optional)
Towing hitch	optional
Cowling	no
Weight	116 kg (with engine, rotor and wheels)





















405 S

Accessory			Optional accessory		
Rotors					
	Rotor Ø 280, 60-50-(40) cm 16 spikes Fixed coupling (can be reduced to 40 cm with kit 69210259)	69219103		Support wheel	Z0020368
				Rear-mounted furrowing tool	L0009800
	Rotor Ø 280, 60-50-(40) cm 16 spikes Quickfit included (can be reduced to 40 cm with kit 69210259)	69219089		Support wheel	Z0020368
				Rear-mounted furrowing tool	L0009800
Front ballast kit					
	Front ballast 7.8 Kg	69209118			
Tyred wheels					
	Pair of tyred wheels 4.00x8" Fixed disc	69209025B		Screw-adjustable half-shafts	69209105
				5-hole adjustable half-shafts	L0059500
				Pair of spacers L 50 mm	69209094
				Pair of snow chains	L1055015
	Pair of tyred wheels 4.00x10" Fixed disc	69200024A		Screw-adjustable half-shafts	69209105
				5-hole adjustable half-shafts	L0059500
				Pair of spacers L 50 mm	69209094
				Pair of snow chains	L0021600
	Pair of tyred wheels 4.00x10" Adjustable disc	69209004B		Pair of 15 kg ballasts (not compatible with adjustable half-shafts)	69209099
				Pair of 18 kg ballasts (compatible with adjustable half-shafts)	69209075
				Screw-adjustable half-shafts	69209105
				5-hole adjustable half-shafts	L0059500
				Pair of spacers L 50 mm	69209094
				Pair of snow chains	L0021600
	Pair of tyred wheels 16-6.50x8" Fixed disc (requires pair of spacers L 50 mm 69209094)	69209012A		Screw-adjustable half-shafts	69209105
				5-hole adjustable half-shafts	L0059500



Accessories







Accessory			Optional accessory		
Steel wheels					
	Pair of steel wheels Ø 480x100 mm	69209067		Pair of width adjustment rings L 100 mm	L0040100
				Screw-adjustable half-shafts	69209105
				5-hole adjustable half-shafts	L0059500
				Pair of spacers L 50 mm	69209094
Towing hitch					
	Towing hitch	69209072			
Drives and Cutter plates					
	Oil-immersed drive	69229096A		0.95 m Complete central cutter plate Semi-fine teeth	69229084A*
				1.15 m Complete central cutter plate Semi-fine teeth	69229085A*
				1.27 m Complete central cutter plate Semi-fine teeth	69229086A*
				0.95 m Complete central cutter plate Special teeth Side protection discs	69229068A
				1.15 m Complete central cutter plate Special teeth Side protection discs	69229069A
				1.27 m Complete central cutter plate Special teeth Side protection discs	69229070A
				1.22 m Complete central cutter plate "UNIVERSAL" ESM (requires kit L0058900)	69229036
				1.02 m Complete central cutter plate "KOMUNAL" ESM (requires kit L0058900)	L0066900
				1.22 m Complete central cutter plate "KOMUNAL" ESM (requires kit L0058900)	69229037
				Ballast for oil-immersed drive	L0105700
				Directional guides for semi-fine tooth cutter plate	69229098

* (recommended for use in conjunction with directional guides 69229098).

Accessories





405 S

Accessory			Optional accessory		
Adjustable tool holder					
	Adjustable tool holder (requires towing hitch 69209072)	L1055001A		Single share plough	Z0020102
				Furrowing tool	Z0020133
				Potato digger	L0066400
QuickFit					
	QuickFit coupling	69212006			
Front shovel					
	Front shovel L 100x40 cm Quickfit coupling With horizontal and vertical adjustment (requires QuickFit 69212006)	69209065			
Snow thrower					
	Turbine L 60 cm Two stages Adjustable ejector chute Quickfit coupling (requires QuickFit 69212006)	L0026200			



Accessories

Accessory			Optional accessory		
Front brush					
	<p>Brush L 100xØ 35 cm With horizontal and vertical adjustment Quickfit coupling (requires QuickFit 69212006)</p>	<p>L0094200</p>			
Rotor type flail mower					
	<p>Flail mower L 50 cm 16 'Y' shaped knives Integral safety brake Adjustable flange Adjustable support roller PTO right-hand rotation Quickfit coupling (requires QuickFit 69212006)</p>	<p>69209119</p>			
Mower					
	<p>Mower L 65 cm Single blade Integral safety brake Adjustable and removable swivel wheels Adjustable lateral skids PTO right-hand rotation Quickfit coupling (requires QuickFit 69212006)</p>	<p>69209008</p>			

Two wheel tractor for intensive use

407 S



Thanks to the differential with locking lever on the handlebars, which affords perfect manoeuvrability and grip even on the most difficult terrain and on slopes, the key strength of this machine is its ease of use. The facility to use a range of different accessories for tillage, grass cutting and maintenance of gardens or urban spaces makes these machines exceptionally versatile and perfectly adapted to meet the needs of demanding home users and smallholders.



Ergonomically positioned easy action levers for differential locking and reverse shuttle.



Independent brakes on each wheel and handlebar steering to facilitate travel on even the most difficult terrain.



QuickFit coupling that allows the operator to change the equipment without using tools.



407 S

Power supply	Engine	Model	Displacement	Power	Starting	Notes	Code
gasoline	POWERED BY HONDA	GX 200 OHV	196 cm ³	5.8 HP	recoil start		68359100E5
gasoline	POWERED BY HONDA	GX 270 OHV	270 cm ³	8.4 HP	recoil start		68359117E5
gasoline	Emak	K 800 H OHV	182 cm ³	5.7 HP	recoil start		68359101E5
gasoline	Emak	K 900 H OHV	252 cm ³	7.0 HP	recoil start		68359119E5
gasoline	KOHLER	CH 270 OHV	208 cm ³	7.0 HP	recoil start		68359104E5
diesel	Emak	K 7000 HD	349 cm ³	6.7 HP	recoil start		68359114E5A
diesel	Emak	K 7000 HD	349 cm ³	6.7 HP	recoil start/ electric	battery supplied as standard	68359123E5

Focus on accessories



Rotor Ø 280, 60-50-(40) cm
16 spikes
Quickfit included
(can be reduced to 40 cm with kit **69210259**)
Code **69219089**



Turbine L 60 cm
Two stages
Adjustable ejector chute
Quickfit coupling
(requires QuickFit **69212006**)
Code **L0026200**



Flail mower L 65 cm
24 'Y' shaped knives
Integral safety brake
Adjustable flange
Adjustable support roller
PTO right-hand rotation
Quickfit coupling
(requires QuickFit **69212006**)
Code **L0091000**



WITH TWO WHEEL TRACTOR

Gearbox/ Speed (km/h):

4-speed (2 forward + 2 reverse) with 4.00-10" wheels

Speed (km/h)	1.20	1	1R	1.27
	2.52	2	2R	2.66

Dimensions (mm)

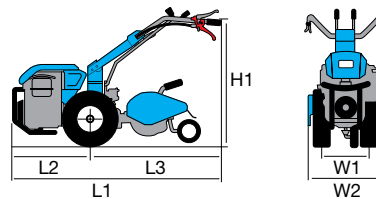

L1	1780
L2	570
L3	1210
H1	1340-470
W1	370
W2	700-400

WITH CUTTERBAR MOWER

Gearbox/ Speed (km/h):

4-speed (2 forward + 2 reverse) with 4.00-10" wheels

Speed (km/h)	1.27	1	1R	1.20
	2.66	2	2R	2.52

Dimensions (mm)

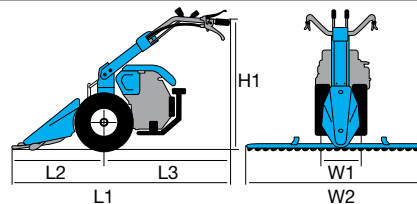













L1	1690
L2	900
L3	790
H1	1440-620
W1	370
W2	1420-950

Transmission	with oil-bath gearbox
Clutch	dry multidisc
Handlebars	with vertical and horizontal adjustment and 180° reversible, with vibration-damping device
Reverse gear	yes, with handlebar lever
Differential	yes
Brakes	yes
Power take-off	independent 973 rpm
Accessories installation	QuickFit (optional)
Towing hitch	yes
Cowling	no
Weight	120 kg (with engine, rotor and wheels)



Accessories

407 S

Accessory			Optional accessory		
Rotors					
 <p>Rotor Ø 280, 60-50-(40) cm 16 spikes Fixed coupling (can be reduced to 40 cm with kit 69210259)</p>	<p>69219103</p>	 <p>Support wheel</p>	<p>Z0020368</p>		
		 <p>Rear-mounted furrowing tool</p>		<p>L0009800</p>	
 <p>Rotor Ø 280, 60-50-(40) cm 16 spikes Quickfit included (can be reduced to 40 cm with kit 69210259)</p>	<p>69219089</p>	 <p>Support wheel</p>	<p>Z0020368</p>		
		 <p>Rear-mounted furrowing tool</p>	<p>L0009800</p>		
 <p>Rotor Ø 320, (80)-70-60-(50) cm 20 spikes Quickfit included Support wheel included (expandable to 80 cm with kit 69210231) (can be reduced to 50 cm with kit 69210229)</p>	<p>69219060</p>	 <p>Rear-mounted furrowing tool</p>	<p>L0009800</p>		
		 <p>Rear-mounted furrowing tool</p>	<p>L0009800</p>		
 <p>Rotor Ø 320, (80)-70-60-(50) cm 20 spikes Fixed coupling Support wheel included (expandable to 80 cm with kit 69210231) (can be reduced to 50 cm with kit 69210229)</p>	<p>69219066</p>	 <p>Rear-mounted furrowing tool</p>	<p>L0009800</p>		
		 <p>Rear-mounted furrowing tool</p>	<p>L0009800</p>		



























Accessories

Accessory		Optional accessory			
Tyred wheels					
	Pair of tyred wheels 4.00x8" Fixed disc	69209025B		Screw-adjustable half-shafts	69209105
				5-hole adjustable half-shafts	L0059500
				Pair of spacers L 50 mm	69209094
				Pair of snow chains	L1055015
	Pair of tyred wheels 4.00x10" Fixed disc	69200024A		Screw-adjustable half-shafts	69209105
				5-hole adjustable half-shafts	L0059500
				Pair of spacers L 50 mm	69209094
				Pair of snow chains	L0021600
	Pair of tyred wheels 4.00x10" Adjustable disc	69209004B		Pair of 15 kg ballasts (not compatible with adjustable half-shafts)	69209099
				Pair of 18 kg ballasts (compatible with adjustable half-shafts)	69209075
				Screw-adjustable half-shafts	69209105
				5-hole adjustable half-shafts	L0059500
				Pair of spacers L 50 mm	69209094
				Pair of snow chains	L0021600
	Pair of tyred wheels 5.00x10" Adjustable disc	69209003B		Pair of 15 kg ballasts (not compatible with adjustable half-shafts)	69209099
				Pair of 18 kg ballasts (compatible with adjustable half-shafts)	69209075
				Screw-adjustable half-shafts	69209105
				5-hole adjustable half-shafts	L0059500
				Pair of spacers L 50 mm	69209094
				Pair of snow chains	L0030200
	Pair of tyred wheels 16-6.50x8" Fixed disc (requires pair of spacers L 50 mm 69209094)	69209012A		Screw-adjustable half-shafts	69209105
				5-hole adjustable half-shafts	L0059500

Accessories



407 S

Accessory		Optional accessory			
Steel wheels					
	Pair of steel wheels Ø 480x100 mm	69209067		Pair of width adjustment rings L 100 mm	L0040100
				Screw-adjustable half-shafts	69209105
				5-hole adjustable half-shafts	L0059500
				Pair of spacers L 50 mm	69209094
Adjustable tool holder					
	Adjustable tool holder	L1055001A		Single share plough	Z0020102
				Furrowing tool	Z0020133
				Potato digger	L0066400
Drives and Cutter plates					
	Oil-immersed drive	69229096A		0.95 m Complete central cutter plate Semi-fine teeth	69229084A*
				1.15 m Complete central cutter plate Semi-fine teeth	69229085A*
				1.27 m Complete central cutter plate Semi-fine teeth	69229086A*
				1.40 m Complete central cutter plate Semi-fine teeth	69229087A*
				0.95 m Complete central cutter plate Special teeth Side protection discs	69229068A
				1.15 m Complete central cutter plate Special teeth Side protection discs	69229069A
				1.27 m Complete central cutter plate Special teeth Side protection discs	69229070A
				1.40 m Complete central cutter plate Special teeth Side protection discs	69229071A
				1.22 m Complete central cutter plate "UNIVERSAL" ESM (requires kit L0058900)	69229036
				1.42 m Complete central cutter plate "UNIVERSAL" ESM (requires kit L0058900)	69229021
				1.02 m Complete central cutter plate "KOMUNAL" ESM (requires kit L0058900)	L0066900
				1.22 m Complete central cutter plate "KOMUNAL" ESM (requires kit L0058900)	69229037
				1.42 m Complete central cutter plate "KOMUNAL" ESM (requires kit L0058900)	69229038
				Ballast for oil-immersed drive	L0105700
	Directional guides for semi-fine tooth cutter plate	69229098			

* (recommended for use in conjunction with directional guides 69229098).



Accessories

Accessory		Optional accessory			
Front shovel					
	<p>Front shovel L 100x40 cm Quickfit coupling With horizontal and vertical adjustment (requires QuickFit 69212006)</p>	69209065			
Snow thrower					
	<p>Turbine L 60 cm Two stages Adjustable ejector chute Quickfit coupling (requires QuickFit 69212006)</p>	L0026200			
Front brush					
	<p>Brush L 100xØ 35 cm With horizontal and vertical adjustment Quickfit coupling (requires QuickFit 69212006)</p>	L0094200			
Rotor type flail mower					
	<p>Flail mower L 65 cm 24 'Y' shaped knives Integral safety brake Adjustable flange Adjustable support roller PTO right-hand rotation Quickfit coupling (requires QuickFit 69212006)</p>	L0091000			
Mower					
	<p>Mower L 65 cm Single blade Integral safety brake Adjustable and removable swivel wheels Adjustable lateral skids PTO right-hand rotation Quickfit coupling (requires QuickFit 69212006)</p>	69209008			
Trailer					
	<p>Towed trailer with handlebar steering Load box dimensions 1.25x0.95 m Load box depth 30 cm Wheels 145x70-8" Max load capacity 300 kg Pedal operated brake Parking handbrake Dump box Collapsible tailgate (not homologated for road use)</p>	L0018601			
QuickFit					
	QuickFit coupling	69212006			
Front ballast					
	<p>Modular front ballast 14 kg (requires installation kit 69202012)</p>	69209129		<p>Modular front ballast 14 kg (two elements)</p>	69209129

Two wheel tractor for intensive use

413 S



Designed for professional users, with a 3-speed gearbox and differential, this machine, in its various different engine versions, is designed to take the most punishing conditions in its stride. Very versatile and safe, with its EHS system for easy clutch control this machine combines ruggedness and exceptional ease of handling. Individual user requirements can be met with the generous range of accessories available.



Ergonomically positioned easy action levers for differential locking and reverse shuttle.



The EHS system ensures ease of use, reduced effort and the maximum simplification for users.



QuickFit coupling that allows the operator to change the equipment without using tools.



413 S

Power supply	Engine	Model	Displacement	Power	Starting	Notes	Code
gasoline	Emak	K 1100 H	302 cm ³	8.4 HP	recoil start		68329237E5
gasoline	HONDA	GX 270 OHV	270 cm ³	8.4 HP	recoil start		68329201E5
gasoline	HONDA	GX 340 OHV	389 cm ³	10.7 HP	recoil start		68329200E5
gasoline	HONDA	GX 390 OHV	389 cm ³	11.7 HP	recoil start		68329241E5
gasoline	KOHLER	CH 395 OHV	277 cm ³	9.5 HP	recoil start		68329206E5
diesel	KOHLER	KD 15 350	349 cm ³	7.5 HP	recoil start		68329226E5
diesel	Emak	K 9000 HD	441 cm ³	9.2 HP	recoil start/ electric	battery supplied as standard	68329235E5A
diesel	KOHLER	KD 15 440	441 cm ³	10.9 HP	recoil start		68329205E5
diesel	KOHLER	KD 15 440	441 cm ³	10.9 HP	recoil start/ electric	battery supplied as standard	68329202E5

Focus on accessories



Rotor Ø 320, (80)-70-60-(50) cm
20 spikes
Quickfit included
Support wheel included
(expandable to 80 cm with kit **69210231**)
(can be reduced to 50 cm with kit **69210229**)
Code **69219060**



Turbine L 60 cm
Two stages
Adjustable ejector chute
Quickfit coupling
(requires QuickFit **69212006**)
Code **L0026200**



Flail mower L 65 cm
24 'Y' shaped knives
Integral safety brake
Adjustable flange
Adjustable support roller
PTO right-hand rotation
Quickfit coupling
(requires QuickFit **69212006**)
Code **L0091000**



WITH TWO WHEEL TRACTOR

Gearbox/ Speed (km/h):

6-speed (3 forward + 3 reverse) with 5.00-10" wheels

Speed (km/h)	1.26	1	1R	1.33
	2.64	2	2R	2.79
	4.37	3	3R	4.62

Dimensions (mm)

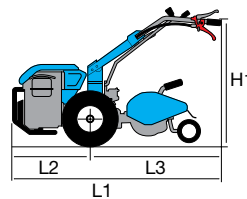

L1	1800
L2	690
L3	1110
H1	1470-630
W1	370
W2	800-400

WITH CUTTERBAR MOWER

Gearbox/ Speed (km/h):

6-speed (3 forward + 3 reverse) with 5.00-10" wheels

Speed (km/h)	1.33	1	1R	1.26
	2.79	2	2R	2.64
	4.62	3	3R	4.37

Dimensions (mm)

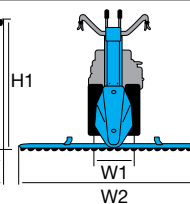
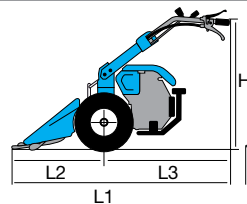





L1	1770
L2	900
L3	870
H1	1440-570
W1	370
W2	1420-950

Transmission	with oil-bath gearbox
Clutch	dry multidisc
Handlebars	with vertical and horizontal adjustment and 180° reversible, with vibration-damping device
Reverse gear	yes, with handlebar lever
Differential	yes
Brakes	yes
Power take-off	independent 973 rpm
Accessories installation	QuickFit (optional)
Towing hitch	yes
Cowling	yes
Weight	130 kg (with diesel engine, rotor and wheels)

Accessories



413 S

Accessory			Optional accessory		
Rotors					
	Rotor Ø 280, 60-50-(40) cm 16 spikes Quickfit included (can be reduced to 40 cm with kit 69210259)	69219089		Support wheel	Z0020368
				Rear-mounted furrowing tool	L0009800
	Rotor Ø 320, (80)-70-60-(50) cm 20 spikes Quickfit included Support wheel included (expandable to 80 cm with kit 69210231) (can be reduced to 50 cm with kit 69210229)	69219060		Rear-mounted furrowing tool	L0009800
				Rear-mounted furrowing tool	L0009800
	Rotor Ø 320, 80-70-60-(50) cm 24 spikes Quickfit included Support wheel included (can be reduced to 50 cm with kit 69210229)	69219055		Rear-mounted furrowing tool	L0009800
				Rear-mounted furrowing tool	L0009800
	Rotor Ø 320, (80)-70-60-(50) cm 20 spikes Fixed coupling Support wheel included (expandable to 80 cm with kit 69210231) (can be reduced to 50 cm with kit 69210229)	69219066		Rear-mounted furrowing tool	L0009800
				Rear-mounted furrowing tool	L0009800





























Accessories

Accessory		Optional accessory			
Tyred wheels					
	Pair of tyred wheels 4.00x8" Fixed disc	69209025B		Screw-adjustable half-shafts	69209105
				5-hole adjustable half-shafts	L0059500
				Pair of spacers L 50 mm	69209094
				Pair of snow chains	L1055015
	Pair of tyred wheels 4.00x10" Fixed disc	69200024A		Screw-adjustable half-shafts	69209105
				5-hole adjustable half-shafts	L0059500
				Pair of spacers L 50 mm	69209094
				Pair of snow chains	L0021600
	Pair of tyred wheels 4.00x10" Adjustable disc	69209004B		Pair of 15 kg ballasts (not compatible with adjustable half-shafts)	69209099
				Pair of 18 kg ballasts (compatible with adjustable half-shafts)	69209075
				Screw-adjustable half-shafts	69209105
				5-hole adjustable half-shafts	L0059500
				Pair of spacers L 50 mm	69209094
				Pair of snow chains	L0021600
	Pair of tyred wheels 5.00x10" Adjustable disc	69209003B		Pair of 15 kg ballasts (not compatible with adjustable half-shafts)	69209099
				Pair of 18 kg ballasts (compatible with adjustable half-shafts)	69209075
				Screw-adjustable half-shafts	69209105
				5-hole adjustable half-shafts	L0059500
				Pair of spacers L 50 mm	69209094
				Pair of snow chains	L0030200
	Pair of tyred wheels 16-6.50x8" Fixed disc (requires pair of spacers L 50 mm 69209094)	69209012A		Screw-adjustable half-shafts	69209105
				5-hole adjustable half-shafts	L0059500

Accessories



413 S

Accessory			Optional accessory		
Steel wheels					
	Pair of steel wheels Ø 480x100 mm	69209067		Pair of width adjustment rings L 100 mm	L0040100
				Screw-adjustable half-shafts	69209105
				5-hole adjustable half-shafts	L0059500
				Pair of spacers L 50 mm	69209094
Adjustable tool holder					
	Adjustable tool holder	L1055001A		Single share plough	Z0020102
				180° turnwrest plough	Z0020104
				Furrowing tool	Z0020133
				Fixed-tine cultivator	L0010200
				Potato digger	L0066400
Drives and Cutter plates					
	Oil-immersed drive	69229096A		0.95 m Complete central cutter plate Semi-fine teeth	69229084A*
				1.15 m Complete central cutter plate Semi-fine teeth	69229085A*
				1.27 m Complete central cutter plate Semi-fine teeth	69229086A*
				1.40 m Complete central cutter plate Semi-fine teeth	69229087A*
				0.95 m Complete central cutter plate Special teeth Side protection discs	69229068A
				1.15 m Complete central cutter plate Special teeth Side protection discs	69229069A
				1.27 m Complete central cutter plate Special teeth Side protection discs	69229070A
				1.40 m Complete central cutter plate Special teeth Side protection discs	69229071A
				1.22 m Complete central cutter plate "UNIVERSAL" ESM (requires kit L0058900)	69229036
				1.42 m Complete central cutter plate "UNIVERSAL" ESM (requires kit L0058900)	69229021
				1.02 m Complete central cutter plate "KOMUNAL" ESM (requires kit L0058900)	L0066900
				1.22 m Complete central cutter plate "KOMUNAL" ESM (requires kit L0058900)	69229037
				1.42 m Complete central cutter plate "KOMUNAL" ESM (requires kit L0058900)	69229038
				Ballast for oil-immersed drive	L0105700
	Directional guides for semi-fine tooth cutter plate	69229098			

* (recommended for use in conjunction with directional guides 69229098).



Accessories

Accessory		Optional accessory		
Front shovel				
	Front shovel L 100x40 cm Quickfit coupling With horizontal and vertical adjustment (requires QuickFit 69212006)	69209065		
Snow thrower				
	Turbine L 60 cm Two stages Adjustable ejector chute Quickfit coupling (requires QuickFit 69212006)	L0026200		
Front brush				
	Brush L 100xØ 35 cm With horizontal and vertical adjustment Quickfit coupling (requires QuickFit 69212006)	L0094200		
Rotor type flail mower				
	Flail mower L 65 cm 24 'Y' shaped knives Integral safety brake Adjustable flange Adjustable support roller PTO right-hand rotation Quickfit coupling (requires QuickFit 69212006)	L0091000		
Mower				
	Mower L 75 cm Single blade Integral safety brake Adjustable and removable swivel wheels Adjustable lateral skids PTO right-hand rotation Quickfit coupling (requires QuickFit 69212006)	69209007		
Two-way rotary plow				
	Rotor Ø 300 mm Clockwise and anti-clockwise rotation Tilt adjustment -38° / -19° / 0° / +19° / +38° Depth adjuster Transport wheel Fixed coupling	69209126		
Trailer				
	Towed trailer with handlebar steering Load box dimensions 1.25x0.95 m Load box depth 30 cm Wheels 145x70-8" Max load capacity 300 kg Pedal operated brake Parking handbrake Dump box Collapsible tailgate (not homologated for road use)	L0018601		
QuickFit				
	QuickFit coupling	69212006		
Front ballast				
	Modular front ballast 14 kg (requires installation kit 69202012)	69209129		Modular front ballast 14 kg (two elements) 69209129

Professional two wheel tractor

417 S



Professional machine with power rating and features that make it ideal for tillage, root crop harvesting and ploughing duties on all terrain types. Combines exceptional ease of handling and versatility with the ability to work on all types of terrain safely, thanks to the self-locking differential and 5-speed gearbox.



The EHS system ensures ease of use, reduced effort and the maximum simplification for users.



Single-disc version, diesel, supplied as standard with protective cowling.



Two power take-offs, one independent two-speed PTO and one synchronised PTO.



417 S

Power supply	Engine	Model	Displacement	Power	Starting	Notes	Code
gasoline	POWERED by HONDA	GX 340 OHV	389 cm ³	10.7 HP	recoil start	multidisc clutch	68339100E5
gasoline	POWERED by HONDA	GX 390 OHV	389 cm ³	11.7 HP	recoil start	mono-disc clutch	68339137E5
gasoline	KOHLER	CH 395 OHV	277 cm ³	9.5 HP	recoil start/ electric	multidisc clutch/ battery supplied as standard	68339116E5
gasoline	KOHLER	CH 440 OHV	429 cm ³	14.0 HP	recoil start/ electric	mono-disc clutch/ battery supplied as standard	68339117E5
diesel	Emak	K 9000 HD	441 cm ³	9.2 HP	recoil start/ electric	multidisc clutch/ battery supplied as standard	68339124E5A
diesel	KOHLER	KD 15 440	441 cm ³	10.9 HP	recoil start	multidisc clutch	68339105E5
diesel	KOHLER	KD 15 440	441 cm ³	10.9 HP	recoil start/ electric	multidisc clutch/ battery supplied as standard	68339101E5
diesel	KOHLER	KD 15 440	441 cm ³	10.9 HP	recoil start/ electric	mono-disc clutch/ lights/ battery supplied as standard	68339120E5
gasoline	POWERED by HONDA	VANGUARD 18	570 cm ³	18.0 HP	recoil start/ electric	mono-disc clutch/ battery supplied as standard	68339132E5

Focus on accessories



Rotor Ø 350, 80-65 cm
16 spikes
Fixed coupling
Support wheel included
Code **69219077**



Single share plough
Code **Z0020102**



Flail mower **L 80 cm**
32 'Y'-shaped knives
Integral safety brake
Adjustable flange
Adjustable support roller
PTO left-hand rotation
Fixed coupling
Code **69209120**



WITH TWO WHEEL TRACTOR

Gearbox/ Speed (km/h):

5-speed (4 forward + 1 reverse) with 6.50/80-12" wheels

Speed (km/h)	1.08	1	1R	2.82
	2.02	2		
	3.61	3		
	7.91	4		

Dimensions (mm)

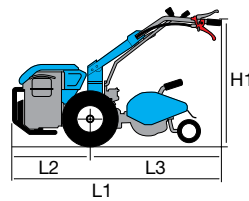

L1	2180
L2	730
L3	1450
H1	600-1300
W1	420-510
W2	600-900

WITH CUTTERBAR MOWER

Gearbox/ Speed (km/h):

5-speed (4 forward + 1 reverse) with 6.50/80-12" wheels

Speed (km/h)	1.08	1	1R	2.82
	2.02	2		
	3.61	3		
	7.91	4		

Dimensions (mm)

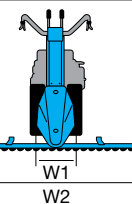
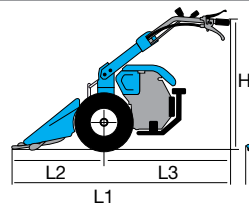

L1	2185
L2	1125
L3	1060
H1	700-1300
W1	430-490
W2	1150-1600

Transmission	with oil-bath gearbox
Clutch	dry multidisc or mono-disc
Handlebars	with vertical and horizontal adjustment and 180° reversible, with vibration-damping device
Reverse gear	yes, with lever alongside gearbox
Differential	yes
Brakes	yes
Power take-off	2 power take-offs: one independent 2-speed PTO (1° 540 rpm - 2° 900 rpm) and one synchronised PTO
Accessories installation	with flange on PTO
Towing hitch	yes
Cowling	yes, with integral tool compartment/battery box
Weight	250 kg (with diesel engine, rotor and wheels)



















Accessories

417 S

Accessory			Optional accessory		
Rotors for engines < 11 HP					
	<p>Rotor Ø 320, (80)-70-60-(50) cm 20 spikes Fixed coupling Support wheel included (expandable to 80 cm with kit 69210231) (can be reduced to 50 cm with kit 69210229)</p>	69219070		Rear-mounted furrowing tool	L0009800
	<p>Rotor Ø 320, 80-70-60-(50) cm 24 spikes Fixed coupling Support wheel included (can be reduced to 50 cm with kit 69210229)</p>	69219068		Rear-mounted furrowing tool	L0009800
Rotors for engines > 11 HP					
	<p>Rotor Ø 350, 80-65 cm 20 spikes Fixed coupling Support wheel included</p>	69219076		Rear-mounted furrowing tool	Z0020134
	<p>Rotor Ø 350, 80-65 cm 16 spikes Fixed coupling Support wheel included</p>	69219077		Rear-mounted furrowing tool	Z0020134



















Accessories

Accessory		Optional accessory		
Tyred wheels				
	Pair of tyred wheels 5.00x10" Adjustable disc	69209003B	 Pair of 15 kg ballasts (not compatible with adjustable half-shafts)	69209099
			 Pair of 18 kg ballasts (compatible with adjustable half-shafts)	69209075
			 Screw-adjustable half-shafts	69209105
			 5-hole adjustable half-shafts	L0059500
			 Pair of spacers L 95 mm	69209095
			 Pair of snow chains	L0030200
	Pair of tyred wheels 5.00x12" Adjustable disc	69209002B	 Pair of ballasts 25 kg (compatible with adjustable half-shafts)	69209077
			 Screw-adjustable half-shafts	69209105
			 5-hole adjustable half-shafts	L0059500
			 Pair of spacers L 95 mm	69209095
	Pair of tyred wheels 6.5/80x12" Adjustable disc	69200038B	 Pair of ballasts 25 kg (compatible with adjustable half-shafts)	69209077
			 Screw-adjustable half-shafts	69209105
			 5-hole adjustable half-shafts	L0059500
			 Pair of spacers L 95 mm	69209095

Accessories







417 S

Accessory			Optional accessory		
Steel wheels					
	Pair of steel wheels Ø 570x125 mm	69209068		Pair of width adjustment rings L 100 mm	69209069
				Screw-adjustable half-shafts	69209105
				5-hole adjustable half-shafts	L0059500
				Pair of spacers L 95 mm	69209095
Adjustable tool holder					
	Adjustable tool holder	Z0020172		Single share plough	Z0020102
				180° turnwrest plough	Z0020104
				Furrowing tool	Z0020133
				Fixed-tine cultivator (not compatible with 5.00x10" wheels)	L0010200
				Potato digger (not compatible with 5.00x10" wheels)	L0066400
Drives and Cutter plates					
	Oil-immersed drive	L0101500A		1.15 m Complete central cutter plate Semi-fine teeth	69229085A*
				1.27 m Complete central cutter plate Semi-fine teeth	69229086A*
				1.40 m Complete central cutter plate Semi-fine teeth	69229087A*
				0.95 m Complete central cutter plate Special teeth Side protection discs	69229068A
				1.15 m Complete central cutter plate Special teeth Side protection discs	69229069A
				1.27 m Complete central cutter plate Special teeth Side protection discs	69229070A
				1.40 m Complete central cutter plate Special teeth Side protection discs	69229071A
				1.22 m Complete central cutter plate "UNIVERSAL" ESM (requires kit L0058900)	69229036
				Ballast for oil-immersed drive	L0105700
				Directional guides for semi-fine tooth cutter plate	69229098
Lighting					
	Supplementary worklight kit (for mono-disc versions, with electric starting only)	69209113			

* (recommended for use in conjunction with directional guides **69229098**).



Accessories

Accessory			Optional accessory		
Roller flail mower					
	<p>Flail mower L 80 cm 32 'Y'-shaped knives Integral safety brake Adjustable flange Adjustable support roller PTO left-hand rotation Fixed coupling</p>	69209120		<p>Front ballast kit (12 kg) for flail mower</p>	69209128
Mower					
	<p>Mower L 75 cm Single blade Integral safety brake Adjustable and removable swivel wheels Adjustable lateral skids PTO left-hand rotation Fixed coupling</p>	69209121			
Two-way rotary plow					
	<p>Rotor Ø 300 mm Clockwise and anti-clockwise rotation Tilt adjustment -38° / -19° / 0° / +19° / +38° Depth adjuster Transport wheel Fixed coupling</p>	69209127			
Front ballast					
	<p>Modular front ballast 14 kg (requires installation kit 69202012) For multi-disc versions only</p>	69209129		<p>Modular front ballast 14 kg (two elements)</p>	69209129

Professional two wheel tractor

418 S



Its characteristics of high power and reliability make this model perfect for farmers and ground care professionals. Combines exceptional ease of handling and versatility with the ability to work on all types of terrain safely, thanks to the self-locking differential and 5-speed gearbox. The powerful engines available for this model are exploited in full thanks to the reinforced half-shafts, while the large size final reduction gears on the axle ensure efficient transmission of the full engine power while increasing the machine's ground clearance.



Reinforced half-shafts with final reduction drives incorporated in the transmission assembly for more grip on difficult terrain.



Two power take-offs, one independent two-speed PTO and one synchronised PTO.



Accessories coupling by means of flange on the PTO.

418 S

Power supply	Engine	Model	Displacement	Power	Starting	Notes	Code
gasoline	POWERED BY HONDA	GX 390 OHV	389 cm ³	11.7 HP	recoil start	mono-disc clutch	68339168E5
gasoline	KOHLER	CH 440 OHV	429 cm ³	14.0 HP	recoil start/ electric	mono-disc clutch/ battery supplied as standard	68339158E5
gasoline		VANGUARD 18	570 cm ³	18.0 HP	recoil start/ electric	mono-disc clutch/ battery supplied as standard	68339163E5

Focus on accessories



Rotor Ø 350, 80-65 cm
16 spikes
Fixed coupling
Support wheel
Code **69219077**



Adjustable tool holder
Code **Z0020172**



180° turnwrest plough
Code **Z0020107**



WITH TWO WHEEL TRACTOR

Gearbox/ Speed (km/h):

5-speed (4 forward + 1 reverse) with 6.50/80-12" wheels

Speed (km/h)	1.08	1	1R	2.82
	2.02	2		
	3.61	3		
	7.91	4		

WITH CUTTERBAR MOWER

Gearbox/ Speed (km/h):

5-speed (4 forward + 1 reverse) with 6.50/80-12" wheels

Speed (km/h)	1.08	1	1R	2.82
	2.02	2		
	3.61	3		
	7.91	4		

Dimensions (mm)

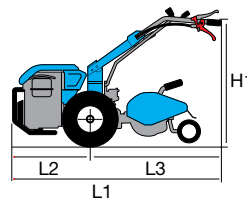

L1	2180
L2	730
L3	1450
H1	600-1300
W1	420-510
W2	600-900

Dimensions (mm)

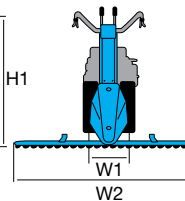
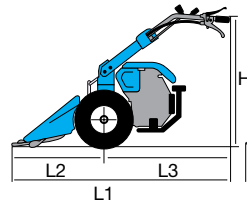

L1	2185
L2	1125
L3	1060
H1	700-1300
W1	450-510
W2	1150-1600

Transmission	with oil-bath gearbox
Clutch	dry mono-disc
Handlebars	with vertical and horizontal adjustment and 180° reversible, with vibration-damping device
Reverse gear	yes, with lever alongside gearbox
Differential	yes
Brakes	yes
Power take-off	2 power take-offs one independent 2-speed PTO (1° 540 rpm - 2° 900 rpm) and one synchronised PTO
Accessories installation	flanged to PTO
Towing hitch	yes
Cowling	yes, with integral tool compartment/battery box
Weight	230 kg (with diesel engine, rotor and wheels)

Accessories



418 S

Accessory			Optional accessory		
Rotors					
	Rotor Ø 350, 80-65 cm 20 spikes Fixed coupling Support wheel	69219076		Rear-mounted furrowing tool	Z0020134
	Rotor Ø 350, 80-65 cm 16 spikes Fixed coupling Support wheel	69219077		Rear-mounted furrowing tool	Z0020134
	Rotor Ø 350, 80-65 cm 20 spikes Fixed coupling with tiller shaft adapter Support wheel (compatible with 6.50/80-15" wheels only)	69219104		Rear-mounted furrowing tool	Z0020134
	Rotor Ø 350, 80-65 cm 16 spikes Fixed coupling with tiller shaft adapter Support wheel (compatible with 6.50/80-15" wheels only)	69219105		Rear-mounted furrowing tool	Z0020134
	Rotor Ø 350, 90-65 cm 16 spikes Fixed coupling with tiller shaft adapter Support wheel (compatible with 6.50/80-15" wheels only)	69219106		Rear-mounted furrowing tool	Z0020134
Tyred wheels					
	Pair of tyred wheels 6.5/80x12" Adjustable disc	69200038B		Pair of ballasts 25 kg (compatible with adjustable half-shafts)	69209077
				Screw-adjustable half-shafts	69209105
				5-hole adjustable half-shafts	L0059500
				Pair of spacers L 95 mm	69209095
	Pair of tyred wheels 6.5/80x15" Adjustable disc	69209013		Pair of ballasts 25 kg	69209077
Steel wheels					
	Pair of steel wheels Ø 570x125 mm	69209068		Pair of width adjustment rings L 100 mm	69209069
				Screw-adjustable half-shafts	69209105
				5-hole adjustable half-shafts	L0059500
				Pair of spacers L 95 mm	69209095
Front ballast					
	Modular front ballast 14 kg (requires installation kit 69202012) For multi-disc versions only	69209129		Modular front ballast 14 kg (two elements)	69209129



Accessories

Accessory			Optional accessory		
Adjustable tool holder					
	Adjustable tool holder	Z0020172		Single share plough	Z0020102
				180° turnwrest plough	Z0020107
				Furrowing tool	Z0020133
				Fixed-tine cultivator	L0010200
				Potato digger	L0066400
Drives and Cutter plates					
	Oil-immersed drive	L0101500A		1.15 m Complete central cutter plate Semi-fine teeth	69229085A*
				1.27 m Complete central cutter plate Semi-fine teeth	69229086A*
				1.40 m Complete central cutter plate Semi-fine teeth	69229087A*
				0.95 m Complete central cutter plate Special teeth Side protection discs	69229068A
				1.27 m Complete central cutter plate Special teeth Side protection discs	69229070A
				1.40 m Complete central cutter plate Special teeth Side protection discs	69229071A
				1.22 m Complete central cutter plate "UNIVERSAL" ESM (requires kit L0058900)	69229036
				Ballast for oil-immersed drive	L0105700
				Directional guides for semi-fine tooth cutter plate	69229098
Roller flail mower					
	Flail mower L 80 cm 32 'Y'-shaped knives Integral safety brake Adjustable flange Adjustable support roller PTO left-hand rotation Fixed coupling	69209120		Front ballast kit (12 kg) for flail mower	69209128
Mower					
	Mower L 75 cm Single blade Integral safety brake Adjustable and removable swivel wheels Adjustable lateral skids PTO left-hand rotation Fixed coupling	69209121			
Two-way rotary plow					
	Rotor Ø 300 mm Clockwise and anti-clockwise rotation Tilt adjustment -38° / -19° / 0° / +19° / +38° Depth adjuster Transport wheel Fixed coupling	69209127			

* (recommended for use in conjunction with directional guides 69229098).

Professional machines for shredding and chopping grass, shoots and green waste generally, powerful and reliable for finishing jobs.

INTENSIVE



BTS 50

			
	5.7	26	50

PROFESSIONAL



BTS 65

			
	8.4-10.7	38	65

BTS 80

			
	10.7	46	80

TECHNICAL DATA



gearbox



power



knives



working width





Flail mowers

Flail mower for intensive use

BTS 50



Compact and high-performance model, designed for home gardeners and professional operators. Grass, shoots, low vegetation and scrub are the ideal working environment. The compact dimensions of the rotor unit make this machine highly manoeuvrable in confined spaces and when moving between work areas. No type of terrain is off-limits, thanks to the large tyred wheels. A versatile machine that easily adapts to different types of environments and cuts.



Cutting unit rotor supported by reinforced bearings and shields, resulting in a machine that is perfectly balanced and resistant to accidental knocks.



Handlebars adjustable vertically and horizontally by means of a comfortable handgrip positioned at the end of the steering column.



Generously sized tyred wheels (4.00-8") to ensure excellent grip on the ground.

BTS 50

Power supply	Engine	Model	Displacement	Power	Starting	Code
gasoline	Emak	K 800 H	182 cm ³	5.7 HP	recoil start	68259100E5

Focus on accessories



**Pair of steel wheels
+ Width adjustment ring**
Steel wheels Ø 410 mm
Code **68242001**



Gearbox/ Speed (km/h):

4-speed (3 forward + 1 reverse) with 4.00-8" wheels

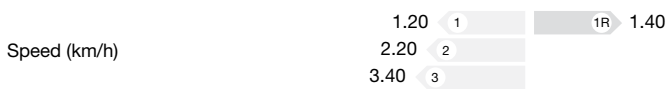

Dimensions (mm)

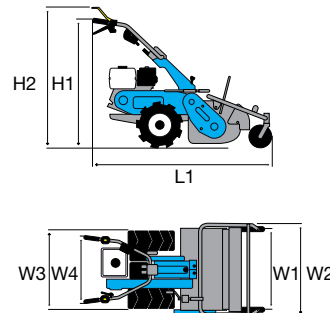

L1	1550
H1	1040
H2	1185
W1	550
W2	670
W3	545
W4	570

Transmission	with oil-bath gearbox
Clutch	belt with tensioner
Steering	with independent steering clutches and wheel lock
Handlebars	with vertical and horizontal adjustment
Cutting unit	rotor with 26 'Y' shaped knives
Working width	50 cm
Cutting height	20 to 80 mm, adjustable with handle
Service brake	with automatic engagement
Front wheels	swivel with lock
Rear wheels	4.00-8"
Weight	135 kg

Professional flail mower

BTS 65



High-performance, reliable model designed for the needs of farmers and professional operators. Grass, shoots, twigs and low vegetation, scrub and stubble: this machine stops at nothing, assuring excellent cleaning of ground, orchards and vineyards thanks to its highly efficient and powerful cutting unit and wide working width.



Independent steering clutches on the driving wheels, with wheel lock, which make the machine extremely easy to handle.



The handlebars have 4 vertical adjustment positions and 5 horizontal adjustment positions.



The front directional wheels can be locked to facilitate work on sloping surfaces.

BTS 65

Power supply	Engine	Model	Displacement	Power	Starting	Code
gasoline	Emak	K 1100 H	302 cm ³	8.4 HP	recoil start	68249008E5
gasoline	POWERED by HONDA	GX 340 OHV	389 cm ³	10.7 HP	recoil start	68249007E5

Focus on accessories



Pair of steel wheels + Width adjustment ring
Steel wheels Ø 410 mm (can be mounted directly on gear unit axle)
Code **68242001**



Pair of metal wheels
Metal wheels Ø 410 x 60 mm (can be mounted on tyred wheels to increase grip, requires spacers **69209103**)
Code **L0756011**



Pair of spacers
L. 100 mm (required for mounting metal wheels in combination with the tyred wheels supplied as standard)
Code **69209103**



Gearbox/ Speed (km/h):

4-speed (3 forward + 1 reverse) with 16/6.50-8" wheels

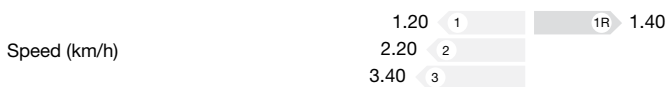

Dimensions (mm)

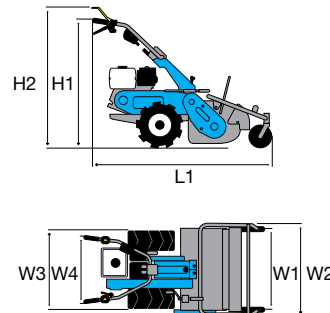

L1	1657
H1	1092
H2	1216
W1	700
W2	814
W3	670
W4	550

Transmission	with oil-bath gearbox
Clutch	belt with tensioner
Steering	with independent steering clutches and wheel lock
Handlebars	with vertical and horizontal adjustment
Cutting unit	rotor with 38 'Y' shaped knives
Working width	65 cm
Cutting height	20 to 80 mm, adjustable with handle
Service brake	with automatic engagement
Front wheels	swivel with lock
Rear wheels	16/6.50-8"
Weight	173.5 kg

Professional flail mower

BTS 80



Extremely high-performance and reliable machine. The large shredding capacity and powerful engines allow for working in extreme conditions and on slopes. Exceptional maneuverability and ease of use ensure excellent results in all conditions of use, as well as total safety at all times.



Rotor with powerful and sturdy 'Y' shaped knives to cut and shred grass and clippings efficiently with no risk of impact or damage.



The gear selection lever on the handlebar is simple to operate.



The service and parking brake engages automatically when the clutch is released, to prevent accidental hazardous movements.

BTS 80

Power supply	Engine	Model	Displacement	Power	Starting	Code
gasoline	POWERED by HONDA	GX 340 OHV	389 cm ³	10.7 HP	recoil start	68249018E5
gasoline	POWERED by HONDA	GX 340 OHV ALPIN	389 cm ³	10.7 HP	recoil start	68249024E5

Focus on accessories



Pair of steel wheels + Width adjustment ring
Steel wheels Ø 410 mm
(can be mounted directly on gear unit axle)
Code **68242001**



Pair of metal wheels
Metal wheels Ø 410 x 60 mm
(can be mounted on tyred wheels to increase grip, requires spacers **69209103**)
Code **L0756011**



Pair of spacers
L. 100 mm
(required for mounting metal wheels in combination with the tyred wheels supplied as standard)
Code **69209103**



Front ballast kit 15 kg
Code **68240193**



Gearbox/ Speed (km/h):

4-speed (3 forward + 1 reverse) with 16/6.50-8" wheels

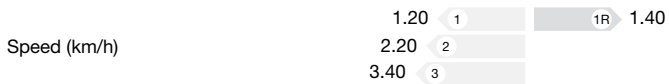

Dimensions (mm)

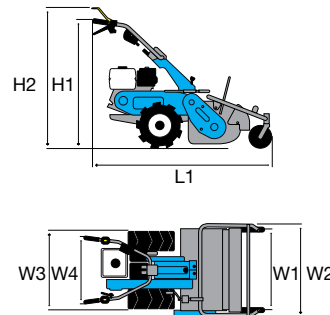

L1	1657
H1	1092
H2	1216
W1	850
W2	964
W3	670
W4	550

Transmission	with oil-bath gearbox
Clutch	belt with tensioner
Steering	with independent steering clutches and wheel lock
Handlebars	with vertical and horizontal adjustment
Cutting unit	rotor with 46 'Y' shaped knives
Working width	80 cm
Cutting height	20 to 80 mm, adjustable with handle
Service brake	with automatic engagement
Front wheels	swivel with lock
Rear wheels	16/6.50-8"
Weight	175 kg

Easy to steer and handle for a precise cut and consistently high performance in all working conditions.

HOME



110



INTENSIVE



130 S



PROFESSIONAL



141



120 S



140



150 S



145 S



150 MS



TECHNICAL DATA



OPTIONAL





Cutterbar mowers

Cutterbar mower for home use

110

Configured for a centrally mounted cutterbar, this lightweight and manoeuvrable machine is designed to meet the requirements of non-professional users.



Handlebars with vertical adjustment to allow the operator to assume the correct posture while working.



Handlebar mounted on vibration dampers.



Integral QuickFit coupling that allows the operator to change the equipment without using tools.

110

Power supply	Engine	Model	Displacement	Power	Starting	Code
gasoline	Emak	K 700 H OHV	182 cm ³	5.4 HP	recoil start	68939001E5

Focus on accessories



Pair of tyred wheels
3.50x6"
Fixed disc
Code **69209107**



Cam drive
Code **69222010**



Complete central cutter plate
0.92 m
Special teeth
Code **69222011**



Gearbox/ Speed (km/h):

1-speed (1 forward) with 3.50-6" wheels

Speed (km/h)

2.30

1

Dimensions (mm)

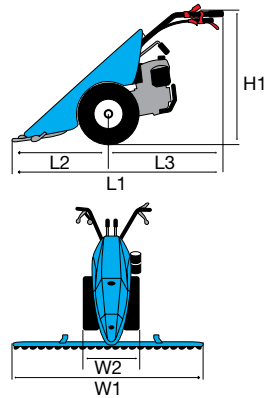

L1	1540
L2	740
L3	800
H1	990
W1	920
W2	400

Transmission	with oil-bath gearbox
Clutch	direct engagement
Handlebars	with vertical adjustment and anti-vibration device
Reverse gear	no
Differential	no
Brakes	no
Power take-off	independent 1017 rpm
Accessories installation	QuickFit supplied as standard
Weight	70 kg (with wheels, bar drive and cutter)

Cutterbar mower for home use

120 S



The machine is primarily used to cut grass and fodder crops and for general field clearing duties. Features such as the vertically and horizontally adjustable handlebars, the QuickFit system, and transmission available also with oil-immersed drive reflect the high level of attention paid to the operator.



Handlebar-mounted PTO control.



Handlebars with vertical and horizontal adjustment and vibration-damping device to assure more comfortable handling.



Integral QuickFit coupling that allows the operator to change the equipment without using tools.

120 S

Power supply	Engine	Model	Displacement	Power	Starting	Code
gasoline	POWERED BY HONDA	GX 160 OHV	163 cm ³	4.8 HP	recoil start	68959003E5
gasoline	Emak	K 800 H OHV	182 cm ³	5.7 HP	recoil start	68959001E5
gasoline	KOHLER	CH 270 OHV	208 cm ³	7.0 HP	recoil start	68959005E5

Focus on accessories



Cam drive
Code **69229091**



Complete central cutter plate
0.92 m
Special teeth
Code **69222011**



Brush L 80-Ø 35 cm
With horizontal and vertical adjustment
Code **L0070000**



Gearbox/ Speed (km/h):

2-speed (1 forward + 1 reverse) with 4.00-8" wheels

Speed (km/h) 3.07 **1** **1R** 1.18

Dimensions (mm)

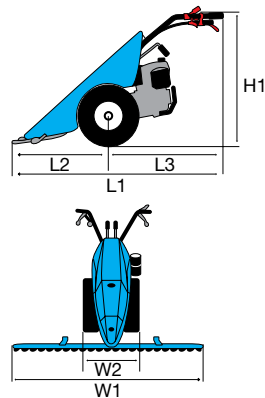

















L1	1465
L2	600
L3	865
H1	1150
W1	920-1220
W2	465

Transmission	with oil-bath gearbox
Clutch	dry multidisc
Handlebars	with vertical and horizontal adjustment and anti-vibration device
Reverse gear	no
Differential	no
Brakes	yes
Power take-off	independent 1004 rpm
Accessories installation	QuickFit supplied as standard
Weight	80 kg (with wheels, bar drive and cutter)

Accessories



120 S

Accessory			Optional accessory		
Tyred wheels					
	Pair of tyred wheels 4.00x8" Fixed disc	69209025B		Pair of snow chains	L1055015
Steel wheels					
	Pair of steel wheels Ø 480x100 mm (installable directly on the hubs or in combination with wheels 69209025B)	69209067		Pair of width adjustment rings L 100 mm	L0040100
Drives and Cutter plates					
	Cam drive	69229091		0.92 m Complete central cutter plate Special teeth	69222011
	Oil-immersed drive	69229028A		0.95 m Complete central cutter plate Semi-fine teeth	69229084A*
				1.15 m Complete central cutter plate Semi-fine teeth	69229085A*
				0.95 m Complete central cutter plate Special teeth Side protection discs	69229068A
				1.15 m Complete central cutter plate Special teeth Side protection discs	69229069A
				1.22 m Complete central cutter plate "UNIVERSAL" ESM (requires kit L0058900)	69229036
				1.02 m Complete central cutter plate "KOMUNAL" ESM (requires kit L0058900)	L0066900
				1.22 m Complete central cutter plate "KOMUNAL" ESM (requires kit L0058900)	69229037
				Directional guides for semi-fine tooth cutter plate	69229098
				Ballast for oil-immersed drive	L0105700
Front brush					
	Brush L 80-Ø 35 cm With horizontal and vertical adjustment	L0070000			

* (recommended for use in conjunction with directional guides 69229098).



Cutterbar mower for intensive use

130 S



Designed for use in small and medium-size plots, this machine combines practicality and lasting reliability, making it ideal for demanding home users and smallholders. The wide range of accessories available, including cutter bars, brushes and snow throwers, meets the requirements also of people seeking a multifunction machine that's safe and easy to use.



Handlebars with vertical and horizontal adjustment and vibration-damping device for more comfortable use of the machine.



The EHS system ensures ease of use, reduced effort and the maximum simplification for users.



Practical forward/reverse shuttle enables the operator to select reverse quickly from any speed. This feature makes the machine exceptionally manoeuvrable in various different work activities.

130 S

Power supply	Engine	Model	Displacement	Power	Starting	Code
gasoline	POWERED BY HONDA	GX 200 OHV	196 cm ³	5.8 HP	recoil start	68949008E5
gasoline	Emak	K 800 H OHV	182 cm ³	5.7 HP	recoil start	68949006E5

Focus on accessories



Brush L 100xØ 35 cm
With horizontal and vertical adjustment
Quickfit coupling
Code **L0094200**



Oil-immersed drive
Code **69229096A**



Front shovel L 100x40 cm
Quickfit coupling
With horizontal and vertical adjustment
Code **69209065**



Gearbox/ Speed (km/h):

4-speed (2 forward + 2 reverse) with 4.00-8" wheels

Speed (km/h)

1.11	1	1R	1.05
2.32	2	2R	2.20

Dimensions (mm)

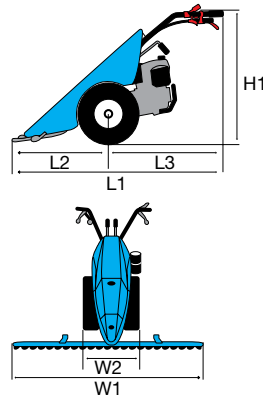



















L1	1670
L2	900
L3	770
H1	1250-300
W1	1270-950
W2	450

Transmission	with oil-bath gearbox
Clutch	dry multidisc
Handlebars	with vertical and horizontal adjustment and vibration-damping device
Reverse gear	yes, with handlebar lever
Differential	no
Brakes	yes
Power take-off	independent 973 rpm
Accessories installation	QuickFit supplied as standard
Weight	105 kg (with wheels, bar drive and cutter)

Accessories



130 S

Accessory			Optional accessory		
Tyred wheels					
	Pair of tyred wheels 4.00x8" Fixed disc	69209025B		Pair of snow chains	L1055015
	Pair of tyred wheels 4.00x10" Fixed disc	69200024A		Pair of snow chains	L0021600
Steel wheels					
	Pair of steel wheels Ø 480x100 mm (requires spacers 69209112)	69209067		Pair of width adjustment rings L 100 mm	L0040100
Drives and Cutter plates					
	Oil-immersed drive	69229096A		0.95 m Complete central cutter plate Semi-fine teeth	69229084A*
				1.15 m Complete central cutter plate Semi-fine teeth	69229085A*
				1.27 m Complete central cutter plate Semi-fine teeth	69229086A*
				0.95 m Complete central cutter plate Special teeth Side protection discs	69229068A
				1.15 m Complete central cutter plate Special teeth Side protection discs	69229069A
				1.27 m Complete central cutter plate Special teeth Side protection discs	69229070A
				1.22 m Complete central cutter plate "UNIVERSAL" ESM (requires kit L0058900)	69229036
				1.02 m Complete central cutter plate "KOMUNAL" ESM (requires kit L0058900)	L0066900
				1.22 m Complete central cutter plate "KOMUNAL" ESM (requires kit L0058900)	69229037
				Ballast for oil-immersed drive	L0105700
				Directional guides for semi-fine tooth cutter plate	69229098

* (recommended for use in conjunction with directional guides 69229098).



Accessories

Accessory			Optional accessory		
Front shovel					
	<p>Front shovel L 100x40 cm Quickfit coupling With horizontal and vertical adjustment</p>	69209065			
Snow thrower					
	<p>Turbine L 60 cm Two stages Adjustable ejector chute Quickfit coupling</p>	L0026200			
Front brush					
	<p>Brush L 100xØ 35 cm With horizontal and vertical adjustment Quickfit coupling</p>	L0094200			
Roller flail mower					
	<p>Flail mower L 50 cm 16 "Y" shaped knives Integral safety brake Adjustable flange Adjustable support roller PTO right-hand rotation Quickfit coupling</p>	69209119			
Mower					
	<p>Mower L 65 cm Single blade Integral safety brake Adjustable and removable swivel wheels Adjustable lateral skids PTO right-hand rotation Quickfit coupling</p>	69209008			

Cutterbar mower for intensive use

140



Configured for a centrally mounted cutterbar, this lightweight and easy-to-handle machine was designed to satisfy the needs of semi-professional users. It is used mainly for cutting grass and forage crops and for field cleaning. Details including the height-adjustable handlebars, rapid forward/reverse shuttle, Quickfit system and optional oil-bath transmission all demonstrate the close attention paid to operator comfort and safety.



Rapid forward/reverse shuttle, controlled from the handlebar: used to invert the operating direction without touching the gears.



Integral QuickFit coupling that allows the operator to change the equipment without using tools.



Handlebars with vertical adjustment and vibration-damping device to assure more comfortable handling.

140

Power supply	Engine	Model	Displacement	Power	Starting	Notes	Code
gasoline	POWERED BY HONDA	GX 160 OHV	163 cm ³	4.8 HP	recoil start		68919051X5
gasoline	Emak	K 900 H OHV	252 cm ³	7.0 HP	recoil start		68919005X5
gasoline	POWERED BY HONDA	GX 270 OHV	270 cm ³	8.4 HP	recoil start		68919055X5
gasoline	KOHLER	CH 395 OHV	277 cm ³	9.5 HP	recoil start		68919059X5
diesel	Emak	K 7000 HD	349 cm ³	6.7 HP	recoil start	as standard with ballast for oil-immersed drive	68919012X5

Focus on accessories



Oil-immersed drive
Code **69229023A**



Front shovel L 100x40 cm
Quickfit coupling
With horizontal and vertical adjustment
Code **69209065**



Brush L 100xØ 35 cm
With horizontal and vertical adjustment
Quickfit coupling
Code **L0094200**



Gearbox/ Speed (km/h):

7-speed (4 forward + 3 reverse) with 4.00-8" wheels

Speed (km/h)	1.05	1	1R	1.11
	2.20	2	2R	2.32
	3.63	3	3R	3.83
	11.38	4		

Dimensions (mm)

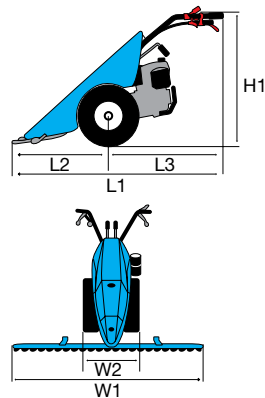

L1	1660 (1665)
L2	900 (950)
L3	760
H1	1250-400
W1	950-1450
W2	437

Transmission	with oil-bath gearbox
Clutch	dry multidisc
Handlebars	with vertical adjustment and anti-vibration device
Reverse gear	yes, with handlebar lever
Differential	no
Brakes	no
Power take-off	independent 973 rpm
Accessories installation	QuickFit supplied as standard
Weight	115 kg (with wheels, bar drive and cutter)



















140

Accessory			Optional accessory		
Tyred wheels					
	Pair of tyred wheels 4.00x8" Fixed disc	69209025B		Pair of spacers L 50 mm	69209094
				Pair of spacers L 130 mm for fitting twin wheels	69209097
				Pair of snow chains	L0021600
	Pair of tyred wheels 4.00x10" Fixed disc	69200024A		Pair of spacers L 50 mm	69209094
				Pair of spacers L 130 mm for fitting twin wheels	69209097
				Pair of snow chains	L0021600
	Pair of tyred wheels 4.00x10" Adjustable disc	69209004B		Pair of spacers L 50 mm	69209094
				Pair of spacers L 130 mm for fitting twin wheels	69209097
				Pair of tyre crampons 10"	L0033800
				Pair of snow chains	L0021600
	Pair of tyred wheels 5.00x10" Adjustable disc	69209003B		Pair of spacers L 50 mm (required for DIESEL engines)	69209094
				Pair of spacers L 150 mm for fitting twin wheels	69209098
				Pair of snow chains	L0030200
	Pair of tyred wheels 16-6.50/8" Fixed disc	69209012A		Pair of spacers L 50 mm (required for assembly)	69209094
	Pair of tyred wheels 18-9.50/8" Fixed disc	69209104		Pair of spacers L 100 mm (required for assembly)	69209103
Steel wheels					
	Pair of steel wheels Ø 480x100 mm	69209067		Pair of width adjustment rings L 100 mm	L0040100



Accessories

Accessory		Optional accessory			
Drives and Cutter plates					
	Oil-immersed drive	69229023A		0.95 m Complete central cutter plate Semi-fine teeth	69229084A*
				1.15 m Complete central cutter plate Semi-fine teeth	69229085A*
				1.27 m Complete central cutter plate Semi-fine teeth	69229086A*
				1.40 m Complete central cutter plate Semi-fine teeth	69229087A*
				0.95 m Complete central cutter plate Special teeth Side protection discs	69229068A
				1.15 m Complete central cutter plate Special teeth Side protection discs	69229069A
				1.27 m Complete central cutter plate Special teeth Side protection discs	69229070A
				1.40 m Complete central cutter plate Special teeth Side protection discs	69229071A
				1.22 m Complete central cutter plate "UNIVERSAL" ESM (requires kit L0058900)	69229036
				1.42 m Complete central cutter plate "UNIVERSAL" ESM (requires kit L0058900)	69229021
				1.02 m Complete central cutter plate "KOMUNAL" ESM (requires kit L0058900)	L0066900
				1.22 m Complete central cutter plate "KOMUNAL" ESM (requires kit L0058900)	69229037
				1.42 m Complete central cutter plate "KOMUNAL" ESM (requires kit L0058900)	69229038
				Directional guides for semi-fine tooth cutter plate	69229098
				Ballast for mechanical drive	L0105500
	Ballast for oil-immersed drive	L0105700			

* (recommended for use in conjunction with directional guides 69229098).

Accessories



140

Accessory			Optional accessory		
Front shovel					
	<p>Front shovel L 100x40 cm Quickfit coupling With horizontal and vertical adjustment</p>	69209065			
Snow thrower					
	<p>Turbine L 60 cm Two stages Adjustable ejector chute Quickfit coupling</p>	L0026200			
Front brush					
	<p>Brush L 100xØ 35 cm With horizontal and vertical adjustment Quickfit coupling</p>	L0094200			
Rotor type flail mower					
	<p>Flail mower L 65 cm 24 "Y" shaped knives Integral safety brake Adjustable flange Adjustable support roller PTO right-hand rotation Quickfit coupling</p>	L0091000			
Mower					
	<p>Mower L 75 cm Single blade Integral safety brake Adjustable and removable swivel wheels Adjustable lateral skids PTO right-hand rotation Quickfit coupling</p>	69209007			



Cutterbar mower for intensive use

145 S



Safety, ergonomics and styling. Every detail is aimed at assuring safe and accurate work operations: with features such as the adjustable height handlebars, rapid reverse shuttle, QuickFit system and transmission with oil-immersed drive, all reflecting the painstaking attention dedicated to the operator.



Ergonomic reverse shuttle with selector lever on the handlebars: allows the direction of travel to be changed without having to change gear.



Integral QuickFit coupling that allows the operator to change the equipment without using tools.



Handlebars with vertical adjustment and vibration-damping device for enhanced operator comfort.

145 S

Power supply	Engine	Model	Displacement	Power	Starting	Notes	Code
gasoline	POWERED by HONDA	GX 160 OHV	163 cm ³	4.8 HP	recoil start		68919209E5
gasoline	Emak	K 900 H OHV	252 cm ³	7.0 HP	recoil start		68919211E5
gasoline	KOHLER	CH 270 OHV	208 cm ³	7.0 HP	recoil start		68919203E5
gasoline	POWERED by HONDA	GX 270 OHV	270 cm ³	8.4 HP	recoil start		68919200E5
gasoline	KOHLER	CH 395 OHV	277 cm ³	9.5 HP	recoil start		68919205E5
diesel	Emak	K 7000 HD	349 cm ³	6.7 HP	recoil start	as standard with ballast for oil-immersed drive	68919213E5

Focus on accessories



Oil-immersed drive
Code **69229096A**



Front shovel L 100x40 cm
Quickfit coupling
With horizontal and vertical adjustment
Code **69209065**



Brush L 100xØ 35 cm
With horizontal and vertical adjustment
Quickfit coupling
Code **L0094200**



Gearbox/ Speed (km/h):

6-speed (3 forward + 3 reverse) with 4.00-8" wheels

Speed (km/h)	1.05	1	1R	1.11
	2.20	2	2R	2.32
	3.63	3	3R	3.83

Dimensions (mm)

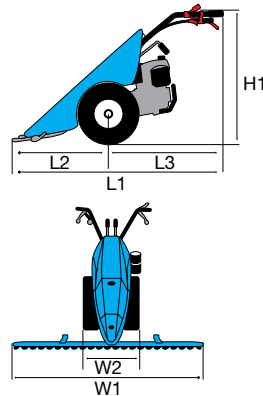























L1	1660 (1665)
L2	900 (950)
L3	760
H1	1250-400
W1	950-1450
W2	437

Transmission	with oil-bath gearbox
Clutch	dry multidisc
Handlebars	with vertical adjustment and anti-vibration device
Reverse gear	yes, with handlebar lever
Differential	no
Brakes	yes
Power take-off	independent 973 rpm
Accessories installation	QuickFit supplied as standard
Weight	115 kg (with wheels, bar drive and cutter)



















145 S

Accessory			Optional accessory		
Tyred wheels					
	Pair of tyred wheels 4.00x8" Fixed disc	69209025B		Pair of spacers L 50 mm	69209094
				Pair of spacers L 130 mm for fitting twin wheels	69209097
				Pair of snow chains	L0021600
	Pair of tyred wheels 4.00x10" Fixed disc	69200024A		Pair of spacers L 50 mm	69209094
				Pair of spacers L 130 mm for fitting twin wheels	69209097
				Pair of snow chains	L0021600
	Pair of tyred wheels 4.00x10" Adjustable disc	69209004B		Pair of spacers L 50 mm	69209094
				Pair of spacers L 130 mm for fitting twin wheels	69209097
				Pair of tyre crampons 10"	L0033800
				Pair of snow chains	L0021600
	Pair of tyred wheels 5.00x10" Adjustable disc	69209003B		Pair of spacers L 50 mm (required for DIESEL engines)	69209094
				Pair of spacers L 150 mm for fitting twin wheels	69209098
				Pair of snow chains	L0030200
	Pair of tyred wheels 16-6.50/8" Fixed disc	69209012A		Pair of spacers L 50 mm (required for assembly)	69209094
	Pair of tyred wheels 18-9.50/8" Fixed disc	69209104		Pair of spacers L 100 mm (required for assembly)	69209103
Steel wheels					
	Pair of steel wheels Ø 480x100 mm	69209067		Pair of width adjustment rings L 100 mm	L0040100



Accessories

Accessory		Optional accessory			
Drives and Cutter plates					
	Oil-immersed drive	69229096A		0.95 m Complete central cutter plate Semi-fine teeth	69229084A*
				1.15 m Complete central cutter plate Semi-fine teeth	69229085A*
				1.27 m Complete central cutter plate Semi-fine teeth	69229086A*
				1.40 m Complete central cutter plate Semi-fine teeth	69229087A*
				0.95 m Complete central cutter plate Special teeth Side protection discs	69229068A
				1.15 m Complete central cutter plate Special teeth Side protection discs	69229069A
				1.27 m Complete central cutter plate Special teeth Side protection discs	69229070A
				1.40 m Complete central cutter plate Special teeth Side protection discs	69229071A
				1.22 m Complete central cutter plate "UNIVERSAL" ESM (requires kit L0058900)	69229036
				1.42 m Complete central cutter plate "UNIVERSAL" ESM (requires kit L0058900)	69229021
				1.02 m Complete central cutter plate "KOMUNAL" ESM (requires kit L0058900)	L0066900
				1.22 m Complete central cutter plate "KOMUNAL" ESM (requires kit L0058900)	69229037
				1.42 m Complete central cutter plate "KOMUNAL" ESM (requires kit L0058900)	69229038
				Directional guides for semi-fine tooth cutter plate	69229098
				Ballast for mechanical drive	L0105500
				Ballast for oil-immersed drive	L0105700

* (recommended for use in conjunction with directional guides 69229098).

Accessories



145 S

Accessory			Optional accessory		
Front shovel					
	<p>Front shovel L 100x40 cm Quickfit coupling With horizontal and vertical adjustment</p>	69209065			
Snow thrower					
	<p>Turbine L 60 cm Two stages Adjustable ejector chute Quickfit coupling</p>	L0026200			
Front brush					
	<p>Brush L 100xØ 35 cm With horizontal and vertical adjustment Quickfit coupling</p>	L0094200			
Rotor type flail mower					
	<p>Flail mower L 65 cm 24 "Y" shaped knives Integral safety brake Adjustable flange Adjustable support roller PTO right-hand rotation Quickfit coupling</p>	L0091000			
Mower					
	<p>Mower L 75 cm Single blade Integral safety brake Adjustable and removable swivel wheels Adjustable lateral skids PTO right-hand rotation Quickfit coupling</p>	69209007			



Professional cutterbar mower

141



The model 141 completes the semi-professional range: this is the ideal machine for mowing grass and forage crops or cleaning in open fields. With an excellent combination of power and easy handling, this cutterbar mower is fitted with independently controlled brakes as standard.



Independent brakes on each wheel supplied as standard.



Practical forward/reverse shuttle enables the operator to change quickly into reverse gear at any speed.



Differential supplied as standard to allow the formation of windrows even when working on a gradient.

141

Power supply	Engine	Model	Displacement	Power	Starting	Notes	Code
gasoline	Emak	K 1100 H	302 cm ³	8.4 HP	recoil start		68919002X5
gasoline	<small>POWERED BY</small> HONDA	GX 270 OHV	270 cm ³	8.4 HP	recoil start		68919025X5
gasoline	KOHLER	CH 395 OHV	277 cm ³	9.5 HP	recoil start		68919030X5
diesel	Emak	K 7000 HD	349 cm ³	6.7 HP	recoil start	as standard with ballast for oil-immersed drive	68919007X5
diesel	LOMBARDINI <small>A KOHLER COMPANY</small>	15LD350	349 cm ³	7.5 HP	recoil start		68919022X5

Focus on accessories



Oil-immersed drive
Code **69229023A**

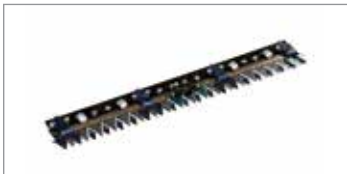

Complete central cutter plate
1.15 m
Special teeth
Side protection discs
Code **69229069A**



Turbine L 60 cm
Two stages
Adjustable ejector chute
Quickfit coupling
Code **L0026200**



Gearbox/ Speed (km/h):

7-speed (4 forward + 3 reverse) with 4.00-10" wheels

Speed (km/h)

1.20	1	1R	1.27
2.57	2	2R	2.66
4.17	3	3R	4.41
13.05	4		

Dimensions (mm)

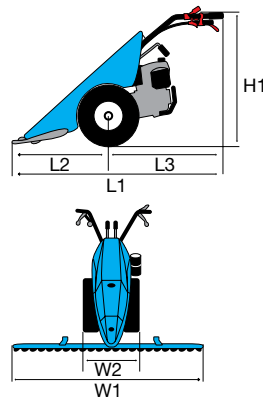

L1	1660 (1665)
L2	900 (950)
L3	760
H1	1255-405
W1	900-1600
W2	445-586

Transmission	with oil-bath gearbox
Clutch	dry multidisc
Handlebars	with vertical adjustment and anti-vibration device
Reverse gear	yes, with handlebar lever
Differential	yes
Brakes	yes
Power take-off	independent 973 rpm
Accessories installation	QuickFit supplied as standard
Weight	135 kg (with wheels, bar drive and cutter)





















141

Accessory		Optional accessory			
Tyred wheels					
	Pair of tyred wheels 4.00x10" Fixed disc	69200024A		Pair of spacers L 50 mm	69209094
				Pair of spacers L 130 mm for fitting twin wheels	69209097
				Pair of snow chains	L0021600
	Pair of tyred wheels 4.00x10" Adjustable disc	69209004B		Pair of spacers L 50 mm	69209094
				Pair of spacers L 130 mm for fitting twin wheels	69209097
				Pair of tyre crampons 10"	L0033800
				Pair of snow chains	L0021600
	Pair of tyred wheels 5.00x10" Adjustable disc	69209003B		Pair of spacers L 50 mm (required for DIESEL engines)	69209094
				Pair of spacers L 150 mm for fitting twin wheels	69209098
				Pair of snow chains	L0030200
	Pair of tyred wheels 18-9.50/8" Fixed disc	69209104		Pair of spacers L 100 mm (required for assembly)	69209103
Steel wheels					
	Pair of steel wheels Ø 480x100 mm	69209067		Pair of width adjustment rings L 100 mm	L0040100



Accessories

Accessory		Optional accessory			
Drives and Cutter plates					
	Oil-immersed drive	69229023A		0.95 m Complete central cutter plate Semi-fine teeth	69229084A*
				1.15 m Complete central cutter plate Semi-fine teeth	69229085A*
				1.27 m Complete central cutter plate Semi-fine teeth	69229086A*
				1.40 m Complete central cutter plate Semi-fine teeth	69229087A*
				1.60 m Complete central cutter plate Semi-fine teeth	69229093A*
				0.95 m Complete central cutter plate Special teeth Side protection discs	69229068A
				1.15 m Complete central cutter plate Special teeth Side protection discs	69229069A
				1.27 m Complete central cutter plate Special teeth Side protection discs	69229070A
				1.40 m Complete central cutter plate Special teeth Side protection discs	69229071A
				1.22 m Complete central cutter plate "UNIVERSAL" ESM (requires kit L0058900)	69229036
				1.42 m Complete central cutter plate "UNIVERSAL" ESM (requires kit L0058900)	69229021
				1.02 m Complete central cutter plate "KOMUNAL" ESM (requires kit L0058900)	L0066900
				1.22 m Complete central cutter plate "KOMUNAL" ESM (requires kit L0058900)	69229037
				1.42 m Complete central cutter plate "KOMUNAL" ESM (requires kit L0058900)	69229038
				Directional guides for semi-fine tooth cutter plate	69229098
				Ballast for mechanical drive	L0105500
	Ballast for oil-immersed drive	L0105700			

* (recommended for use in conjunction with directional guides 69229098).

Accessories



141

Accessory			Optional accessory		
Front shovel					
	<p>Front shovel L 100x40 cm Quickfit coupling With horizontal and vertical adjustment</p>	69209065			
Snow thrower					
	<p>Turbine L 60 cm Two stages Adjustable ejector chute Quickfit coupling</p>	L0026200			
Front brush					
	<p>Brush L 100xØ 35 cm With horizontal and vertical adjustment Quickfit coupling</p>	L0094200			
Rotor type flail mower					
	<p>Flail mower L 65 cm 24 "Y" shaped knives Integral safety brake Adjustable flange Adjustable support roller PTO right-hand rotation Quickfit coupling</p>	L0091000			
Mower					
	<p>Mower L 75 cm Single blade Integral safety brake Adjustable and removable swivel wheels Adjustable lateral skids PTO right-hand rotation Quickfit coupling</p>	69209007			



Professional cutterbar mower

150 S



Safety, ergonomics, versatility. The ideal machine for cutting grass and forage crops in open field conditions and for clearing activities. With the optimal combination of power and manageability, this cutterbar mower is equipped as standard with independently controlled brakes and differential.



Independently controlled brakes as standard with parking function.



Practical reverse shuttle to select reverse gear rapidly at any speed.



Differential supplied as standard to allow the formation of windrows even when working on a gradient.

150 S

Power supply	Engine	Model	Displacement	Power	Starting	Notes	Code
gasoline	Emak	K 1100 H	302 cm ³	8.4 HP	recoil start		68919255E5
gasoline	POWERED by HONDA	GX 270 OHV	270 cm ³	8.4 HP	recoil start		68919250E5
gasoline	KOHLER	CH 395 OHV	277 cm ³	9.5 HP	recoil start		68919259E5
diesel	Emak	K 7000 HD	349 cm ³	6.7 HP	recoil start	as standard with ballast for oil-immersed drive	68919257E5
diesel	LOMBARDINI <small>A KOHLER COMPANY</small>	KD 15 350	349 cm ³	7.5 HP	recoil start		68919253E5

Focus on accessories



Oil-immersed drive
Code **69229096A**



Complete central cutter plate
1.15 m
Special teeth
Side protection discs
Code **69229069A**



Turbine L 60 cm
Two stages
Adjustable ejector chute
Quickfit coupling
Code **L0026200**



Gearbox/ Speed (km/h):

6-speed (3 forward + 3 reverse) with 4.00-10" wheels

Speed (km/h)	1.20	1	1R	1.27
	2.57	2	2R	2.66
	4.17	3	3R	4.41

Dimensions (mm)

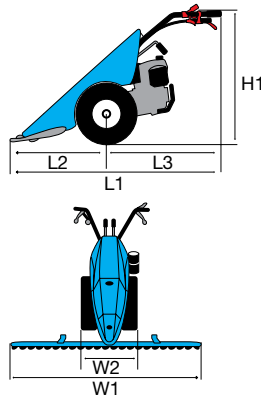

L1	1660 (1665)
L2	900 (950)
L3	760
H1	1255-405
W1	900-1600
W2	445-586

Transmission	with oil-bath gearbox
Clutch	dry multidisc
Handlebars	with vertical adjustment and anti-vibration device
Reverse gear	yes, with handlebar lever
Differential	yes
Brakes	yes
Power take-off	independent 973 rpm
Accessories installation	QuickFit supplied as standard
Weight	135 kg (with wheels, bar drive and cutter)





















150 S

Accessory			Optional accessory		
Tyred wheels					
	Pair of tyred wheels 4.00x10" Fixed disc	69200024A		Pair of spacers L 50 mm	69209094
				Pair of spacers L 130 mm for fitting twin wheels	69209097
				Pair of snow chains	L0021600
	Pair of tyred wheels 4.00x10" Adjustable disc	69209004B		Pair of spacers L 50 mm	69209094
				Pair of spacers L 130 mm for fitting twin wheels	69209097
				Pair of tyre crampons 10"	L0033800
				Pair of snow chains	L0021600
	Pair of tyred wheels 5.00x10" Adjustable disc	69209003B		Pair of spacers L 50 mm (required for DIESEL engines)	69209094
				Pair of spacers L 150 mm for fitting twin wheels	69209098
				Pair of snow chains	L0030200
	Pair of tyred wheels 18-9.50/8" Fixed disc	69209104		Pair of spacers L 100 mm (required for assembly)	69209103
Steel wheels					
	Pair of steel wheels Ø 480x100 mm	69209067		Pair of width adjustment rings L 100 mm	L0040100



Accessories

Accessory		Optional accessory		
Drives and Cutter plates				
 <p>Oil-immersed drive</p>	69229096A		0.95 m Complete central cutter plate Semi-fine teeth	69229084A*
			1.15 m Complete central cutter plate Semi-fine teeth	69229085A*
			1.27 m Complete central cutter plate Semi-fine teeth	69229086A*
			1.40 m Complete central cutter plate Semi-fine teeth	69229087A*
			1.60 m Complete central cutter plate Semi-fine teeth	69229093A*
			0.95 m Complete central cutter plate Special teeth Side protection discs	69229068A
			1.15 m Complete central cutter plate Special teeth Side protection discs	69229069A
			1.27 m Complete central cutter plate Special teeth Side protection discs	69229070A
			1.40 m Complete central cutter plate Special teeth Side protection discs	69229071A
			1.22 m Complete central cutter plate "UNIVERSAL" ESM (requires kit L0058900)	69229036
			1.42 m Complete central cutter plate "UNIVERSAL" ESM (requires kit L0058900)	69229021
			1.02 m Complete central cutter plate "KOMUNAL" ESM (requires kit L0058900)	L0066900
			1.22 m Complete central cutter plate "KOMUNAL" ESM (requires kit L0058900)	69229037
			1.42 m Complete central cutter plate "KOMUNAL" ESM (requires kit L0058900)	69229038
			1.62 m Complete central cutter plate "KOMUNAL" ESM (requires kit L0058900)	69229020
			Directional guides for semi-fine tooth cutter plate	69229098
			Ballast for mechanical drive	L0105500
	Ballast for oil-immersed drive	L0105700		

* (recommended for use in conjunction with directional guides 69229098).

Accessories



150 S

Accessory			Optional accessory		
Front shovel					
	<p>Front shovel L 100x40 cm Quickfit coupling With horizontal and vertical adjustment</p>	69209065			
Snow thrower					
	<p>Turbine L 60 cm Two stages Adjustable ejector chute Quickfit coupling</p>	L0026200			
Front brush					
	<p>Brush L 100xØ 35 cm With horizontal and vertical adjustment Quickfit coupling</p>	L0094200			
Rotor type flail mower					
	<p>Flail mower L 65 cm 24 "Y" shaped knives Integral safety brake Adjustable flange Adjustable support roller PTO right-hand rotation Quickfit coupling</p>	L0091000			
Mower					
	<p>Mower L 75 cm Single blade Integral safety brake Adjustable and removable swivel wheels Adjustable lateral skids PTO right-hand rotation Quickfit coupling</p>	69209007			



Professional cutterbar mower

150 MS



Safety, ergonomics, high performance. Professional model ideal for use on mountainous terrain, for cutting grass, hay making and field clearing duties: this is a powerful machine that's well suited to working on fields with a steep gradient.



Steering clutches with control in combination with the brakes allow the machine to turn 360° with a minimum turning radius.



Half-shafts with final reduction gears to improve grip on steep inclines.



Independently controlled brakes and parking brake.

150 MS

Power supply	Engine	Model	Displacement	Power	Starting	Notes	Code
gasoline	Emak	K 1100 H	302 cm ³	8.4 HP	recoil start		68919356E5
gasoline	KOHLER	CH 395 OHV	277 cm ³	9.5 HP	recoil start		68919352E5
gasoline	POWERED by HONDA	GX 340 OHV	389 cm ³	10.7 HP	recoil start		68919350E5
gasoline	POWERED by HONDA	GX 340 OHV ALPIN	389 cm ³	10.7 HP	recoil start	high inclination engine	68919361E5
diesel	Emak	K 7000 HD	349 cm ³	6.7 HP	recoil start	as standard with ballast for oil-immersed drive	68919358E5
diesel	LOMBARDINI A KOHLER COMPANY	KD 350	349 cm ³	7.5 HP	recoil start		68919354E5

Focus on accessories



Oil-immersed drive
Code **69229096A**



Complete central cutter plate 1.22 m "KOMUNAL" ESM
(requires kit **L0058900**)
Code **69229037**



Pair of steel wheels
Ø 480x100 mm
Code **69209067**



Gearbox/ Speed (km/h):

6-speed (3 forward + 3 reverse) with 5.00-10" wheels

Speed (km/h)

1.27	1	1R	1.34
2.72	2	2R	2.82
4.42	3	3R	4.68

Dimensions (mm)

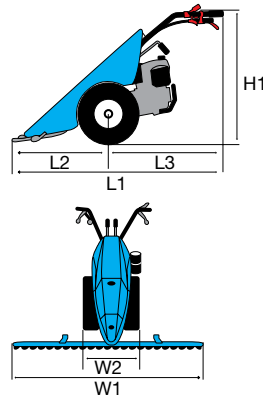

L1	1765
L2	950
L3	860
H1	1260-410
W1	1270-1620
W2	715-800

Transmission	with oil-bath gearbox
Clutch	dry multidisc
Handlebars	with vertical adjustment and anti-vibration device
Reverse gear	yes, with handlebar lever
Differential	yes, with steering clutches controlled in combination with the brakes
Brakes	yes
Power take-off	independent 973 rpm
Accessories installation	QuickFit supplied as standard
Weight	175 kg (with wheels, bar drive and cutter)



















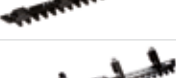

150 MS

Accessory			Optional accessory		
Tyred wheels					
	Pair of tyred wheels 4.00x10" Fixed disc	69200024A		Pair of spacers L 50 mm	69209094
				Pair of spacers L 130 mm for fitting twin wheels	69209097
				Pair of snow chains	L0021600
	Pair of tyred wheels 4.00x10" Adjustable disc	69209004B		Pair of spacers L 50 mm	69209094
				Pair of spacers L 130 mm for fitting twin wheels	69209097
				Pair of tyre crampons 10"	L0033800
				Pair of snow chains	L0021600
	Pair of tyred wheels 5.00x10" Adjustable disc	69209003B		Pair of spacers L 50 mm (required for DIESEL engines)	69209094
				Pair of spacers L 150 mm for fitting twin wheels	69209098
				Pair of snow chains	L0030200
	Pair of tyred wheels 5.00x10" Fixed disc	69200023A		Pair of spacers L 150 mm for fitting twin wheels	69209098
				Pair of snow chains	L0030200
	Pair of tyred wheels 21-11.00/8" Fixed disc Pair of L 65 mm spacers included (P0000705A)	69200021A			
Steel wheels					
	Pair of steel wheels Ø 480x100 mm	69209067		Pair of width adjustment rings L 100 mm	L0040100



Accessories

Accessory		Optional accessory		
Drives and Cutter plates				
 <p>Oil-immersed drive</p>	69229096A		0.95 m Complete central cutter plate Semi-fine teeth	69229084A*
			1.15 m Complete central cutter plate Semi-fine teeth	69229085A*
			1.27 m Complete central cutter plate Semi-fine teeth	69229086A*
			1.40 m Complete central cutter plate Semi-fine teeth	69229087A*
			1.60 m Complete central cutter plate Semi-fine teeth	69229093A*
			0.95 m Complete central cutter plate Special teeth Side protection discs	69229068A
			1.15 m Complete central cutter plate Special teeth Side protection discs	69229069A
			1.27 m Complete central cutter plate Special teeth Side protection discs	69229070A
			1.40 m Complete central cutter plate Special teeth Side protection discs	69229071A
			1.22 m Complete central cutter plate "UNIVERSAL" ESM (requires kit L0058900)	69229036
			1.42 m Complete central cutter plate "UNIVERSAL" ESM (requires kit L0058900)	69229021
			1.02 m Complete central cutter plate "KOMUNAL" ESM (requires kit L0058900)	L0066900
			1.22 m Complete central cutter plate "KOMUNAL" ESM (requires kit L0058900)	69229037
			1.42 m Complete central cutter plate "KOMUNAL" ESM (requires kit L0058900)	69229038
			1.62 m Complete central cutter plate "KOMUNAL" ESM (requires kit L0058900)	69229020
			Directional guides for semi-fine tooth cutter plate	69229098
			Ballast for mechanical drive	L0105500
	Ballast for oil-immersed drive	L0105700		

* (recommended for use in conjunction with directional guides 69229098).

Accessories



150 MS

Accessory			Optional accessory		
Front shovel					
	<p>Front shovel L 100x40 cm Quickfit coupling With horizontal and vertical adjustment</p>	69209065			
Snow thrower					
	<p>Turbine L 60 cm Two stages Adjustable ejector chute Quickfit coupling</p>	L0026200			
Front brush					
	<p>Brush L 100xØ 35 cm With horizontal and vertical adjustment Quickfit coupling</p>	L0094200			
Rotor type flail mower					
	<p>Flail mower L 65 cm 24 "Y" shaped knives Integral safety brake Adjustable flange Adjustable support roller PTO right-hand rotation Quickfit coupling</p>	L0091000			
Mower					
	<p>Mower L 75 cm Single blade Integral safety brake Adjustable and removable swivel wheels Adjustable lateral skids PTO right-hand rotation Quickfit coupling</p>	69209007			



Tough, compact and easy to handle,
for moving bulky and heavy
loads effortlessly across all kinds of terrain.

HOME



BTR 340



INTENSIVE



BTR 450



PROFESSIONAL



BTR 550



BTR 550 D



BTR 1750 D

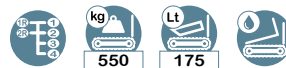

TECHNICAL DATA



gearbox



load capacity



manual dumping



hydraulic dumping



liquid capacity





Transporters

Transporter for home use

— BTR 340



Designed for demanding home users needing to transport all types of material, such as firewood, fruit crates, and other bulky items, this machine is practical and easy to handle on all types of terrain.



Handlebar-mounted gear selection lever.



Speed selection control lever.



Manual dump with automatic locking system.

— BTR 340

Power supply	Engine	Model	Displacement	Power	Starting	Code
gasoline	POWERED BY HONDA	GCVx 170 OHC	166 cm ³	4.4 HP	recoil start	68719048E5
gasoline	Emak	K 655 OHV	166 cm ³	3.9 HP	recoil start	68719044E5

Focus on accessories



High sides kit
Code **68722010**



Front shovel 85 cm
Code **69209071**



Gearbox/ Speed (km/h):

4-speed (2 forward + 2 reverse)

Speed (km/h)

1.60	1	1R	1.40
3.60	2	2R	3.40

Dimensions (mm)

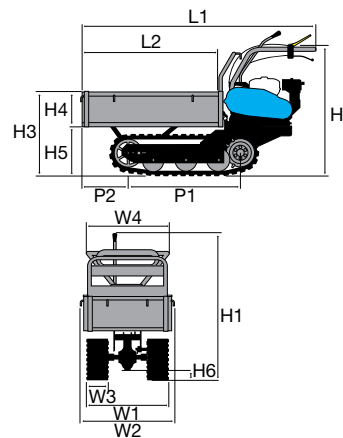

L1	1530-1665
L2	925-1060
H1	965
H2	885
H3	570
H4	240
H5	330
H6	65
W1	590
W2	603-983
W3	170
W4	520-900
P1	690
P2	415-550

Transmission	with oil-bath gearbox
Clutch	belt, with automatic disengagement when the control lever is released
Brakes	with automatic engagement when clutch is released
Load capacity	350 kg
Loading surface	telescoping
Dumping	manual
Dump angle	45°
Steering	with independent control releases and brakes
Minimum steering radius	70 cm
Crawler contact surface	58 cm length – 17 cm width
Power take-off	no
Weight	140 kg

Transporter for intensive use

BTR 450



Designed to meet the needs of demanding users, this model stands out for its manoeuvrability, ruggedness, and generous load capacity. It is also equipped with a power take-off to drive accessories.



Belt clutch with automatic disengagement when the control lever is released.



Steering with independently controlled releases and brakes.



Protected, expandable brakes for working in extreme conditions.

BTR 450

Power supply	Engine	Model	Displacement	Power	Starting	Code
gasoline	Emak	K 800 H	182 cm ³	5.7 HP	recoil start	68729130E5
gasoline	POWERED BY HONDA	GX 160 OHV	163 cm ³	4.8 HP	recoil start	68729114E5

Focus on accessories



High sides kit
Code **68722003**



Front shovel 85 cm
Code **69209071**



Gearbox/ Speed (km/h):

4-speed (3 forward + 1 reverse)

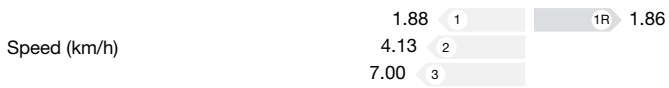

Dimensions (mm)

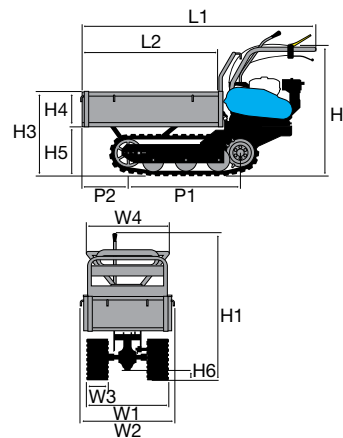

L1	1670
L2	925-1060
H1	1020
H2	900
H3	590
H4	240
H5	339
H6	70
W1	620
W2	643
W3	-
W4	560-940
P1	785
P2	330

Transmission	with oil-bath gearbox
Clutch	belt, with automatic disengagement when the control lever is released
Brakes	with automatic engagement when clutch is released
Load capacity	450 kg
Loading surface	telescoping
Dumping	manual
Dump angle	50°
Steering	with independent control releases and brakes
Minimum steering radius	70 cm
Crawler contact surface	60 cm length - 18 cm width
Power take-off	yes, independent 2100 rpm
Weight	180 kg

Professional transporter

— BTR 550



This is a powerful professional machine, rugged and compact, and ideal for use on all types of terrain. With high load capacity, this machine stands out for its versatility and the safety devices installed.



Independent PTO at 2100 rpm.



Steering with independently controlled releases and brakes.



Telescoping loading platform for transporting even the most bulky loads.

— BTR 550

Power supply	Engine	Model	Displacement	Power	Starting	Code
gasoline	Emak	K 800 H	182 cm ³	5.7 HP	recoil start	68729134E5
gasoline	HONDA <small>POWERED by</small>	GX 160 OHV	163 cm ³	4.8 HP	recoil start	68729118E5

Focus on accessories



High sides kit
Code **68722004**



Front shovel 85 cm
Code **69209071**



Gearbox/ Speed (km/h):

6-speed (4 forward + 2 reverse)

Speed (km/h)	1.88	1	1R	1.86
	3.16	2	2R	3.13
	4.13	3		
	7.00	4		

Dimensions (mm)

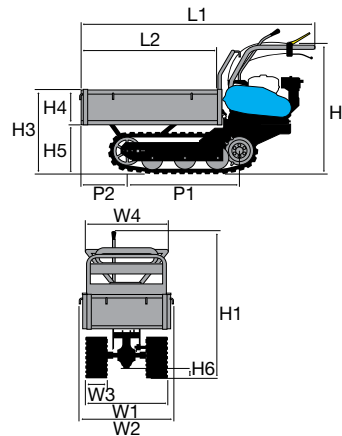

L1	1745
L2	1000-1180
H1	1020
H2	900
H3	590
H4	240
H5	339
H6	70
W1	620
W2	733
W3	-
W4	650-1100
P1	785
P2	405

Transmission	with oil-bath gearbox
Clutch	belt, with automatic disengagement when the control lever is released
Brakes	with automatic engagement when clutch is released
Load capacity	550 kg
Loading surface	telescoping
Dumping	manual
Dump angle	50°
Steering	with independent control releases and brakes
Minimum steering radius	70 cm
Crawler contact surface	60 cm length - 18 cm width
Power take-off	yes, independent 2100 rpm
Weight	200 kg

Professional transporter

— BTR 550 D



Professional model offering a combination of high power, easy handling and high load capacity. The transporter is ideal for applications in the agricultural and building sectors. Tipping is hydraulically operated to provide the maximum possible assistance for the operator during material handling activities.



Lever-operated hydraulic tipping control valve.



Steering with independently controlled releases and brakes.



Protected, expandable brakes for working in extreme conditions.

— BTR 550 D

Power supply	Engine	Model	Displacement	Power	Starting	Code
gasoline	POWERED BY HONDA	GX 160 OHV	163 cm ³	4.8 HP	recoil start	68729128E5

Focus on accessories



High sides kit
Code **68722004**



Front shovel 85 cm
Code **69209071**



Gearbox/ Speed (km/h):

6-speed (4 forward + 2 reverse)

Speed (km/h)	1.88	1	1R	1.86
	3.16	2	2R	3.13
	4.13	3		
	7.00	4		

Dimensions (mm)

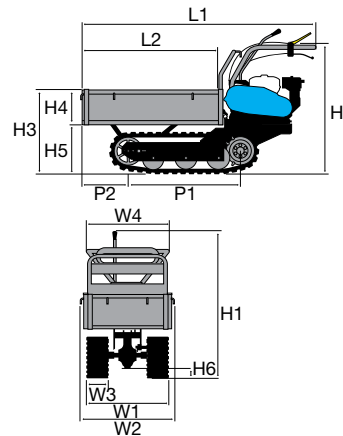

L1	1745
L2	1000-1180
H1	1020
H2	900
H3	590
H4	240
H5	339
H6	70
W1	620
W2	733
W3	-
W4	650-1100
P1	785
P2	405

Transmission	with oil-bath gearbox
Clutch	belt, with automatic disengagement when the control lever is released
Brakes	with automatic engagement when clutch is released
Load capacity	550 kg
Loading surface	telescoping
Dumping	hydraulic
Dump angle	50°
Steering	with independent control releases and brakes
Minimum steering radius	70 cm
Crawler contact surface	60 cm length - 18 cm width
Power take-off	yes, independent 2100 rpm
Weight	215 kg

Professional transporter



— BTR 1750 D

Designed for professional use, this is a dumper model machine with hydraulically operated load box tipping: ideal for transporting firewood, stone, sand and other building materials. Its increased dumping angle - 60° - meets the need for creating piles and mounds. Suited to all kinds of terrain, even on slopes, this transporter has a small steering radius, making it easy to handle.



Lever-operated hydraulic tipping control valve.



Dumper loading platform with counter-frame for 60° dump angle.



Crawler tracks made of hard rubber, width 180 mm: assure excellent grip on all types of terrain.

— BTR 1750 D

Power supply	Engine	Model	Displacement	Power	Starting	Code
gasoline	POWERED BY HONDA	GX 160 OHV	163 cm ³	4.8 HP	recoil start	68729122E5

Focus on accessories



Front shovel 85 cm
Code **69209071**



Extendable loading deck
550 kg payload
Code **68722017**



Gearbox/ Speed (km/h):

6-speed (4 forward + 2 reverse)

Speed (km/h)	1.88	1	1R	1.86
	3.16	2	2R	3.13
	4.13	3		
	7.00	4		

Dimensions (mm)

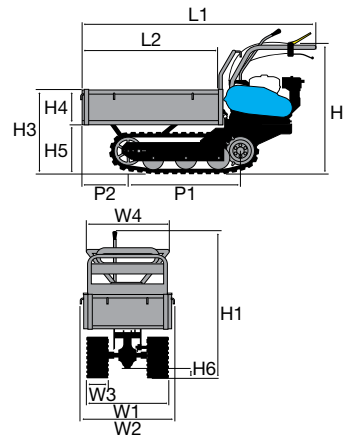

L1	1575
L2	915
H1	1020
H2	900
H3	515-725
H4	405
H5	320
H6	70
W1	622
W2	622
W3	-
W4	620
P1	785
P2	265

Transmission	with oil-bath gearbox
Clutch	belt, with automatic disengagement when the control lever is released
Brakes	with automatic engagement when clutch is released
Load capacity	550 kg - 175 L
Loading surface	fixed
Dumping	hydraulic
Dump angle	60°
Steering	with independent control releases and brakes
Minimum steering radius	70 cm
Crawler contact surface	60 cm length - 18 cm width
Power take-off	yes, independent 2100 rpm
Weight	215 kg

Working calmly and efficiently:
the peace of mind that comes from safety.





Boots, Lubricants and sundry Accessories

Protective Clothing

Chain resistant boots

Combining the characteristics of trekking boots with the safety features required by specific PPE regulations. Chain resistant certified to EN ISO 17249 Class 2 (Category 3 PPE, able to resist chain speeds of up to **24 m/s**). Flexible and comfortable, these boots assure a high level of comfort during work activities, maximising control and mobility. The boots offer excellent grip thanks to the deep channel tread pattern of the sole in anti-oil, antistatic, non-slip nitrile rubber with heat resistance up to 300°C.



Safety	<ul style="list-style-type: none"> • CE approval, standards EN ISO 17249:2013, EN ISO 20345:2011, CL2 S3-CI-HI-HRO-SRC, Class 2. • Category 3 PPE. Certified to EU 2016/425. 			
Materials	<ul style="list-style-type: none"> • Water-repellent leather upper. • Breathable nonwoven fabric lining. • High-strength fabric anti-piercing sole plate. • 8-layer chain protection from top of foot up to the shin and on the sides. 			
Sizes	35 3655011	39 3655015	43 001000977C	47 001001421A
	36 3655012	40 001001419A	44 001000978C	
	37 3655013	41 001000975C	45 001000979C	
	38 3655014	42 001000976C	46 001001420A	

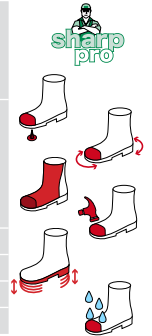

H₂OUT chain resistant boots

Combining the characteristics of trekking boots with the safety features required by specific PPE regulations. Chain resistant certified to EN ISO 17249 Class 2 (Category 3 PPE, able to resist chain speeds of up to **24 m/s**). Flexible and comfortable, these boots assure a high level of comfort during work activities, maximising control and mobility. The boots offer excellent grip thanks to the deep channel tread pattern of the sole in anti-oil, antistatic, non-slip nitrile rubber with heat resistance up to 300°C. The boots provide the maximum impermeability thanks to the "Tepor" membrane interposed between the upper and the lining.



Safety	<ul style="list-style-type: none"> • CE approval, standards EN ISO 17249:2013, EN ISO 20345:2011, CL2 S3-CI-HI-HRO-SRC, Class 2. • Category 3 PPE. Certified to EU 2016/425. 			
Materials	<ul style="list-style-type: none"> • Water-repellent leather upper. • Breathable nonwoven fabric lining. • High-strength fabric anti-piercing sole plate. • 8-layer chain protection from top of foot up to the shin and on the sides. 			
Sizes	40 3655001	42 3655003	44 3655005	46 3655007
	41 3655002	43 3655004	45 3655006	47 3655008



Chain resistant boots

Protection from cutting, crushing and piercing thanks to the steel toe cap, chain guard protection covering the entire upper and anti-piercing sole plate made of high strength fabric. The boots offer excellent grip thanks to the deep channel tread pattern of the sole in anti-oil, antistatic, non-slip nitrile rubber with heat resistance up to 300°C.



Safety	<ul style="list-style-type: none"> • CE approval standards EN 345-1 1997, EN 345-2 1996 SB - E, Class 3. • Category 3 PPE. Certified to EU 2016/425. • KWF PROF certification. 			
Materials	<ul style="list-style-type: none"> • Outer in rubber with non-slip rubber sole with deep cleated tread. • Breathable fabric lining and absorbent felt footbed. • Protective steel toecap, anti-piercing sole plate and ankle guard. • Chain protection on top of foot and on shin. 			
Sizes	41	001001079A	44	001001082A
	42	001001080A	45	001001083A
	43	001001081A		



Protective Clothing

Universal utility gloves

Comfortable, made with synthetic leather palm and comfort padding, back in stretch polyester. Knitted cuff and Velcro fastener for easy on/off, maximum comfort also when worn for long periods.



Safety	<ul style="list-style-type: none"> • CE marking, compliant with EN 420 2003 - AM1: 2009 EN 388: 2003 / 3122 and directive 89/686/EEC. • category 1 PPE. 			
Materials	<ul style="list-style-type: none"> • Back in elasticized polyester and synthetic leather. • Comfort padding on palm. • Elasticated cuffs. • Wrist strap with Velcro. • High strength seams stitched with cotton faced nylon thread. 			
Sizes	S-8	3655024	XL-11	3655027
	M-9	3655025	XXL-12	3655028
	L-10	3655026		



Professional protective and noise-filtering ear defenders

Professional ear defenders for maximum hearing protection, 32 dB attenuation.



Safety	<ul style="list-style-type: none"> • EN 352-1 approved ear defenders. • Category 2 PPE. 		
Materials	<ul style="list-style-type: none"> • Shell made of UV-resistant ABS (shock absorbent). • Stainless steel headband. • Adjustable. • Attenuation (SNR): 32 dB. • PVC + foam sound insulation. 		
Sizes	Universal	3155013R	



Noise filtering ear defenders

Ear defenders for excellent hearing protection, 30 dB attenuation.



Safety	<ul style="list-style-type: none"> • EN 352-1 approved ear defenders. • Category 2 PPE. 		
Materials	<ul style="list-style-type: none"> • Shell in ABS. • Plastic + stainless steel headband. • Adjustable. • Attenuation (SNR) 30 dB. • PVC + foam sound insulation. 		
Sizes	Universal	001000835	



Noise filtering ear defenders

Ear defenders for excellent hearing protection, 27 dB attenuation.



Safety	<ul style="list-style-type: none"> • EN 352-1 approved ear defenders. • Category 2 PPE. 		
Materials	<ul style="list-style-type: none"> • Shell in PVC. • Plastic headband. • Adjustable. • Attenuation (SNR): 27 dB. • PVC + foam sound insulation. 		
Sizes	Universal	4175114	



Protective Clothing



Dark protective spectacles

Versatile, lightweight and ergonomic protective spectacles, dark lens.



Safety	<ul style="list-style-type: none"> • Protective spectacles approved to EN 166. • Optical class 1. 		
Materials	<ul style="list-style-type: none"> • Wrap-around clear anti-scratch lens, anti-glare in sunlight, resistant to fogging. • Brow-pad, temples and nose bridge in soft anti-slip thermoplastic, for greater comfort and greater protection against dust and droplets. The wraparound lens offers a wide field of vision, while the adjustable temple and lens inclination allows for a customised fit. • Mechanical strength: Lens FT - Frame FT. 		
Sizes	<table border="0"> <tr> <td>Universal</td> <td>3155026BR</td> </tr> </table>	Universal	3155026BR
Universal	3155026BR		



Clear protective spectacles

Adjustable, lightweight and ergonomic protective spectacles, clear lens.



Safety	<ul style="list-style-type: none"> • Protective spectacles approved to EN 166 (2C-1.2 1FTKN / Z87+U6). • Optical class 1. 		
Materials	<ul style="list-style-type: none"> • Wrap-around clear anti-scratch lens, anti-glare in sunlight, resistant to fogging. • Brow-pad, temples and nose bridge in soft anti-slip thermoplastic, for greater comfort and greater protection against dust and droplets. The wraparound lens offers a wide field of vision, while the adjustable temple and lens inclination allows for a customised fit. • Mechanical strength: Lens FT - Frame FT. 		
Sizes	<table border="0"> <tr> <td>Universal</td> <td>3155027AR</td> </tr> </table>	Universal	3155027AR
Universal	3155027AR		



Super-professional face shield

Professional lightweight ergonomic face shield for the maximum safety, mesh and polycarbonate protection.



Safety	<ul style="list-style-type: none"> • EN 1731-S approved. 		
Materials	<ul style="list-style-type: none"> • PVC structure, replaceable and adjustable metal mesh face shield. • Foam brow band. 		
Sizes	<table border="0"> <tr> <td>Universal</td> <td>001000939A</td> </tr> </table>	Universal	001000939A
Universal	001000939A		



Safety	<ul style="list-style-type: none"> • EN 166 approved. • Optical class 1, mechanical strength B. 		
Materials	<ul style="list-style-type: none"> • PVC structure, polycarbonate face shield, antifogging, adjustable, replaceable. • Foam brow band. 		
Sizes	<table border="0"> <tr> <td>Universal</td> <td>001000940A</td> </tr> </table>	Universal	001000940A
Universal	001000940A		



Plus face shield

Lightweight ergonomic face shield for the maximum safety, mesh and polycarbonate protection.



Safety	<ul style="list-style-type: none"> • EN 1731-F approved. • Optical class 1, mechanical strength B. 		
Materials	<ul style="list-style-type: none"> • PVC structure, metal mesh face shield, adjustable, replaceable. • Foam brow band. 		
Sizes	<table border="0"> <tr> <td>Universal</td> <td>001000941A</td> </tr> </table>	Universal	001000941A
Universal	001000941A		



Safety	<ul style="list-style-type: none"> • EN 166 approved. • Optical class 1, mechanical strength B. 		
Materials	<ul style="list-style-type: none"> • PVC structure, polycarbonate face shield, antifogging, adjustable, replaceable. • Foam brow band. 		
Sizes	<table border="0"> <tr> <td>Universal</td> <td>001000942A</td> </tr> </table>	Universal	001000942A
Universal	001000942A		



Lubricants and sundry Accessories

Special oil for 4-stroke engines - SAE 10 W - 30

Highly refined SAE 10 W - 30 grade mineral oil, specifically formulated and developed for 4-stroke air- and water-cooled engines designed for gardening sector applications. Mineral type engine oil containing a special combination of additives that give excellent detergent/dispersant, antioxidant, anticorrosive, and anti-wear properties. Exceeds API SG/CE, MIL - L - 2104 D, MIL - L - 46152 C specifications.



200 l drum

3555024

ADDITIX 2000 EVO special additive for petrol fuels

Special additive ideal for conditioning two-stroke mixture and leaded or unleaded petrol. Prevents deterioration of fuel for at least 12 months and protects against oxidation. Facilitates starting, keeps fuel system clean (up to the intake valves in the case of 4-stroke engines), and protects against rust and corrosion. It also increases the octane rating. The dispersing-detergent agents in the product disperse any traces of water in the fuel. Pack of 24 x 125 ml bottles. Two full doser caps are sufficient for 5 l of petrol.



125 ml bottle

001000972A

Fuel can

Fuel can, approved for transporting fuel on the road by the SNCH accreditation agency in compliance with the applicable United Nations standard. Equipped with a flexible extension spout for optimal refueling in all conditions and a "level band" for rapid identification of the remaining fuel level; max capacity 5L. Top quality fuel can, suitable for professional and private use. Pack: carton.



5 l fuel can

4175169A

Performance, powerful and reliability.





Emak Engines

Emak Agricultural Engines Line,
performance, powerful and reliability.
Available in different configurations,
Gasoline or Diesel.



ENGINE LINE-UP



K 300 H



K 800 H
K 800 HC
K 800 HT



K 900 H
K 900 HR



K 1100 H



K 7000 HD
K 7000 HDR



K 9000 HD

Emak Engines Agricultural Line

Horizontal shaft engines are available in different displacements for every needs. Main features like, easy to start, easy to use, powerful engine selections and Stage 5 compliance, are standard on whole range. OHV technology, available on all range, permit a long life offering ever high performance.

- **Easy to start:** distribution system and wide starter pulley, permits a safe and low effort starting.
- **Oil bath filter:** twin stage, sponge and oil; it retains dirty particles before entering into the combustion chamber: that extends the overall engine life.
- **Full compatibility:** these powerful and compact engines, gasoline or diesel, also equipped with an electric starter, offer the perfect solution for the different agricultural works.
- **Easy to maintain:** cleaning the main parts (air filter, sparking plug, starter pulley etc.) and also the oil refilling are very quick due to its specific construction layout.



Stage 5
Low emission engines, compliant with European emission standards (STAGE 5).



OHV technology
Overhead valve (OHV) engine is a piston engine whose valves are located in the cylinder head above the combustion chamber. Perfect and stable performance also during heavy use.



Oil bath filter
Twin stage filter system in oil bath. It also retains the thinnest powder particles.



Automatic decompressor
Decompression is the process by which the air mixture present inside the cylinder is pushed out prior to the engine starting. This automatic system permits to reduce the effort during the starting steps.



KeyGo
Electric starter device: the engine starting is made through an electric motor connected to the crankshaft and activated by a key-operated switch.



Gasoline
Gasoline fuel type engine.



Diesel
Diesel fuel type engine.

Agricultural engines line

K 300 H



Dimensions

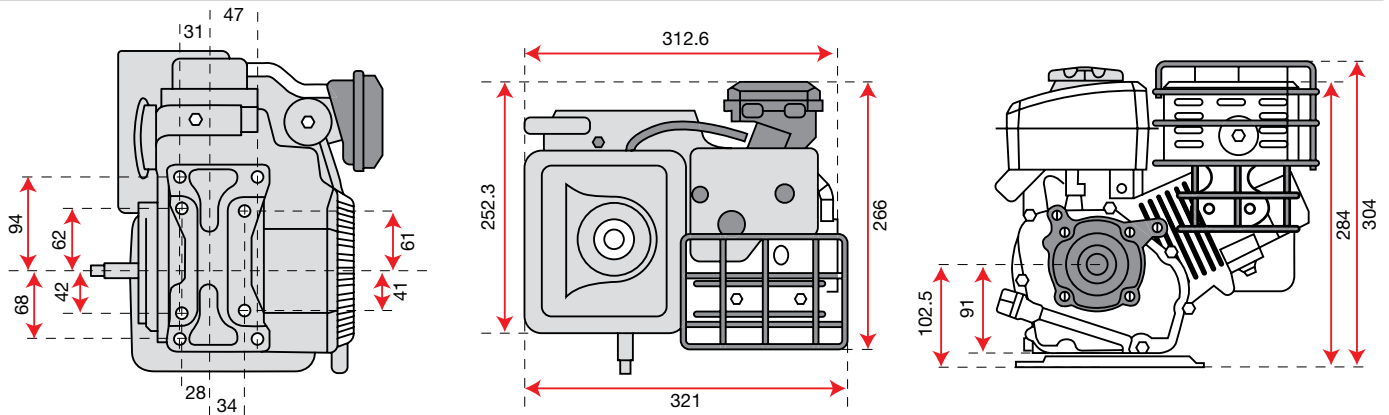

Engine p/n 3075274

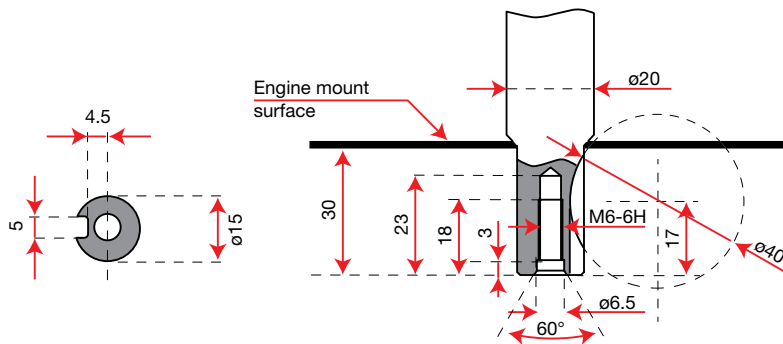

Technical data

Net power	2.2 HP - 1.65 kW / 2900 rpm
Net torque	4.5 N.m / 3450 rpm
Bore x Stroke	48.6 mm x 43 mm
Displacement	79.77 cc
Starting	Recoil start
Fuel capacity	1.6 L
Oil capacity	0.35 L
Dimension	325 x 260 x 310 mm
Net weight	12.8 kg

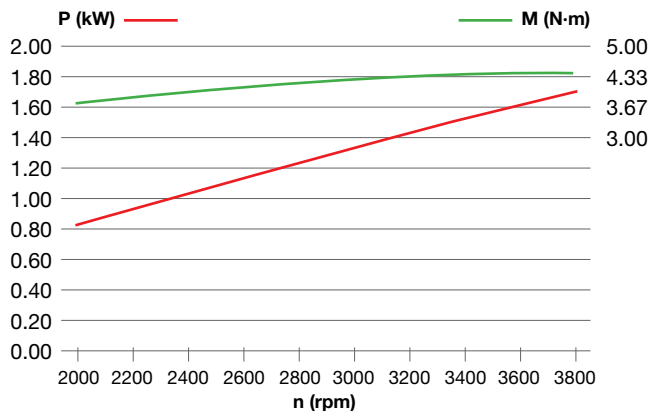

Agricultural engines line

K 800 H - HC - HT



Dimensions

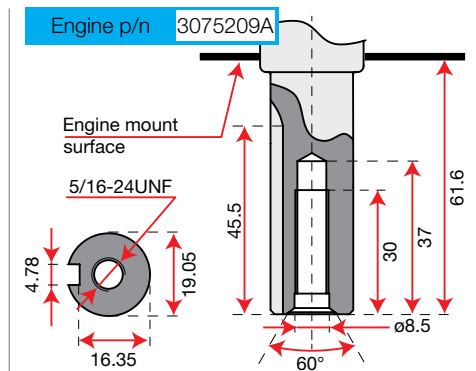
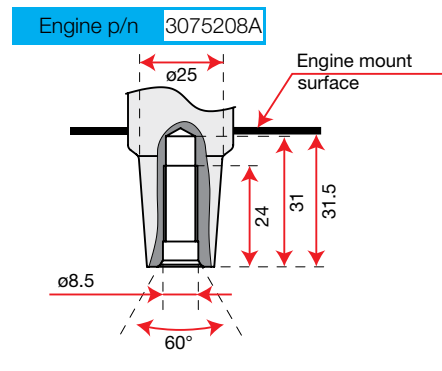
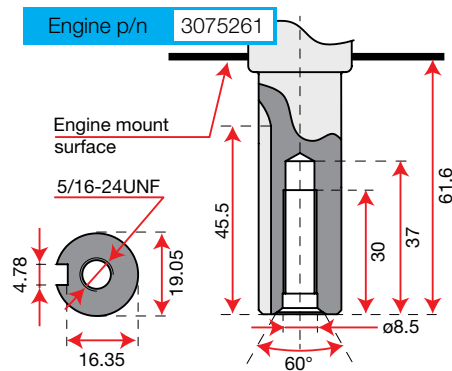
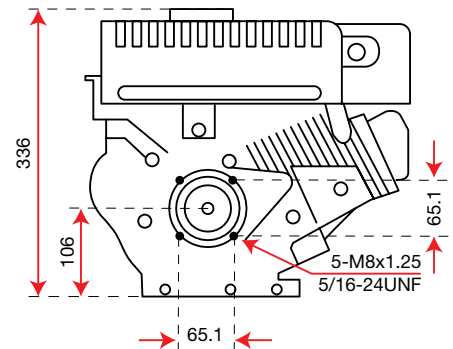
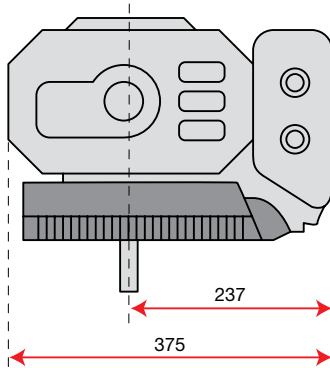
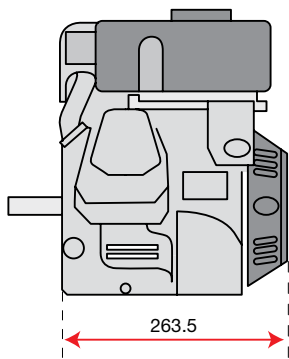

Technical data

Net power	5.7 HP - 4.2 kW / 3600 rpm
Net torque	10.8 N.m / 2500 rpm
Bore x Stroke	65 mm x 55 mm
Displacement	182 cc
Starting	Recoil start
Fuel capacity	3.0 L
Oil capacity	0.6 L
Dimension	263.5 x 375 x 336 mm
Net weight	16 kg

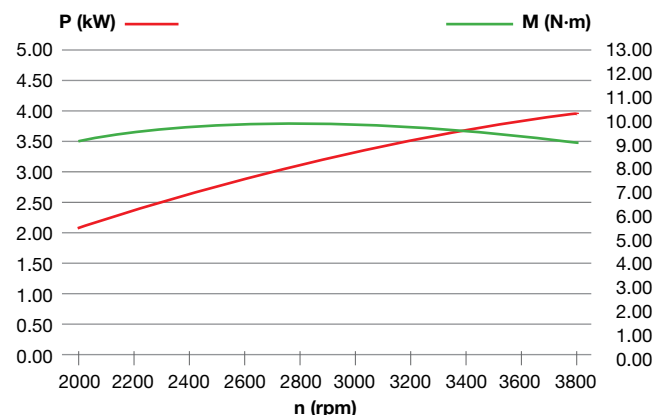

Agricultural engines line

K 900 H - HR



Dimensions

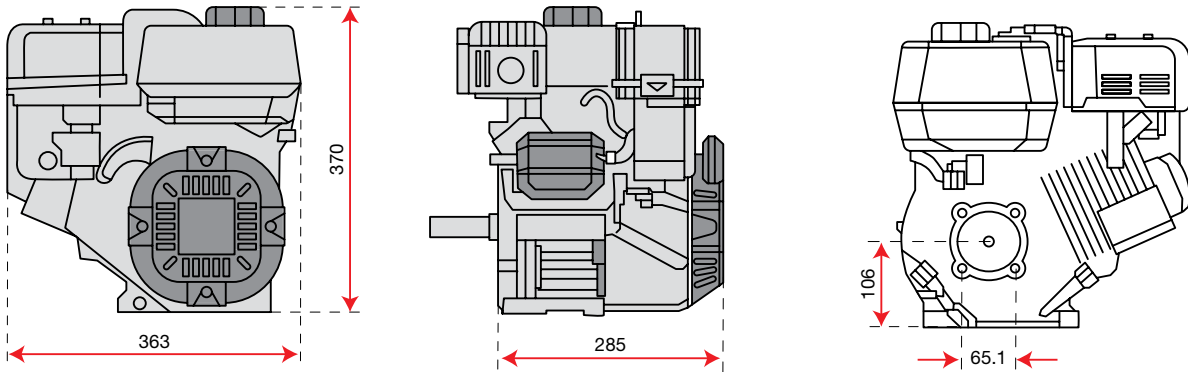

Engine p/n 3075305

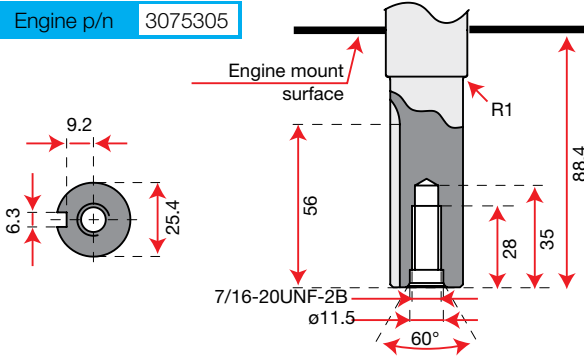

Engine p/n 3075210

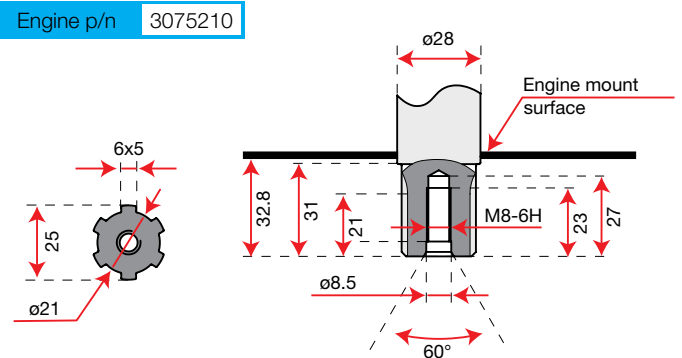

Technical data

Net power	7.0 HP - 5.2 kW / 3600 rpm
Net torque	15.6 N.m / 2600 rpm
Bore x Stroke	75 mm x 57 mm
Displacement	252 cc
Starting	Recoil start
Fuel capacity	4.0 L
Oil capacity	0.7 L
Dimension	363 x 285 x 370 mm
Net weight	16.5 kg

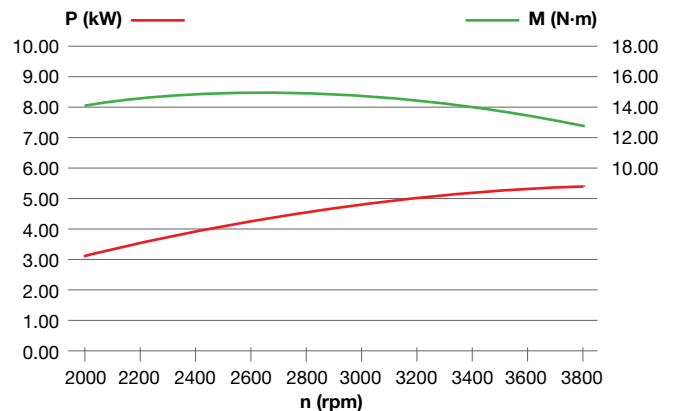

Agricultural engines line

K 1100 H



Dimensions

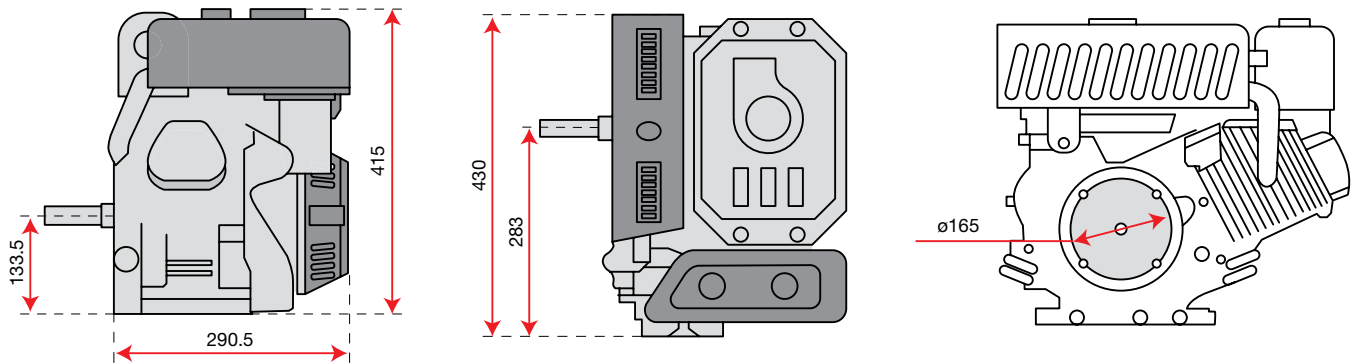

Engine p/n 3075262

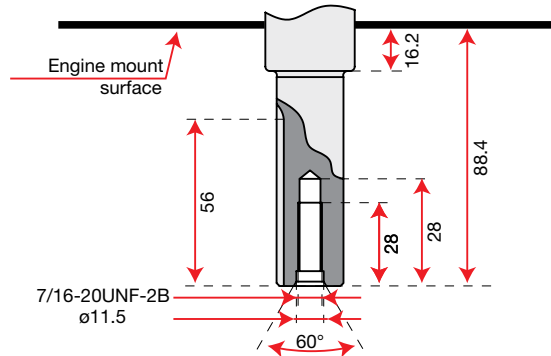
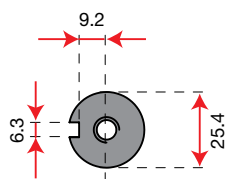

Technical data

Net power	8.4 HP - 6.2 kW / 3600 rpm
Net torque	18.5 N.m / 2500 rpm
Bore x Stroke	80 mm x 60 mm
Displacement	302 cc
Starting	Recoil start
Fuel capacity	4.6 L
Oil capacity	0.9 L
Dimension	290.5 x 430 x 415 mm
Net weight	26.5 kg

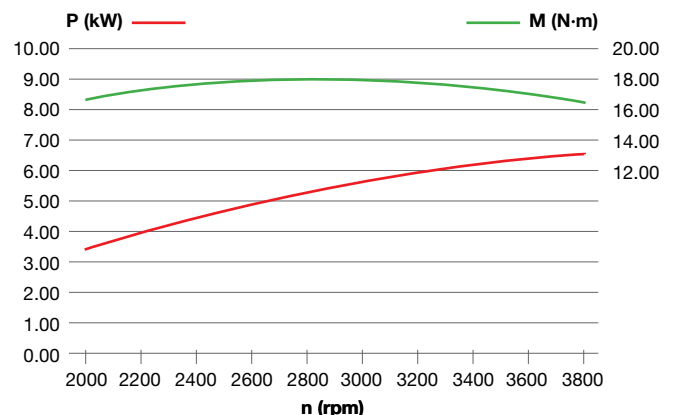

Agricultural engines line

K 7000 HD - HDR



electric version

Dimensions

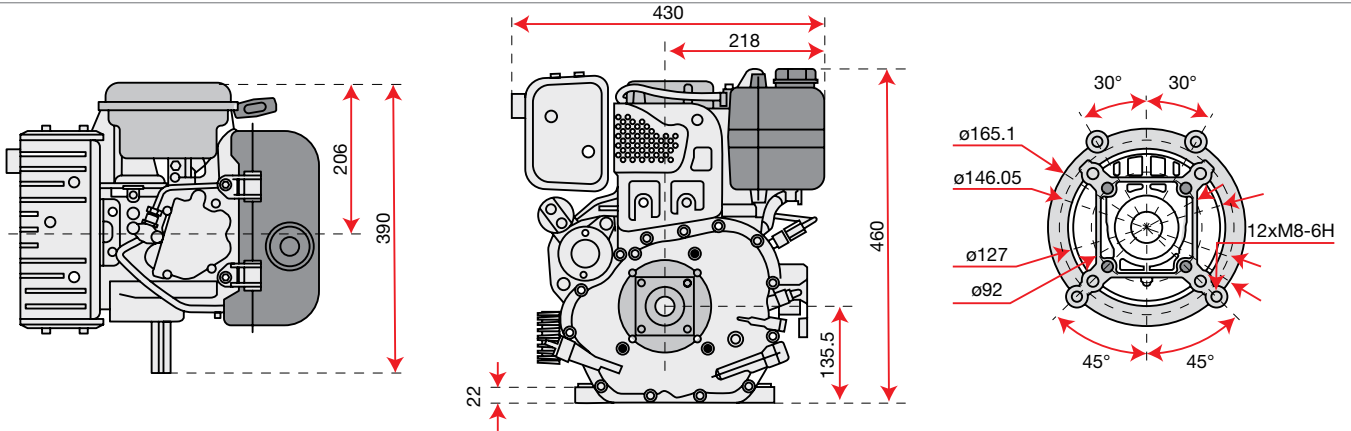

Engine p/n 3175016A

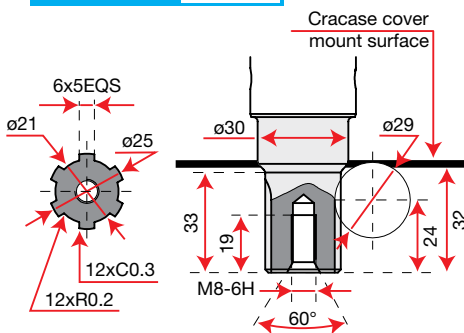

Engine p/n 3175040

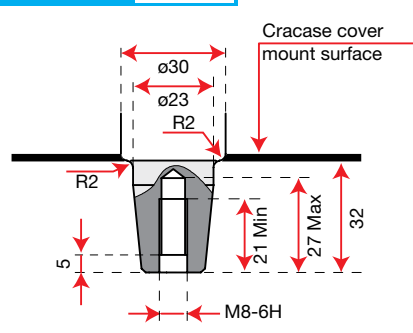

Engine p/n 3175038* - 3175039

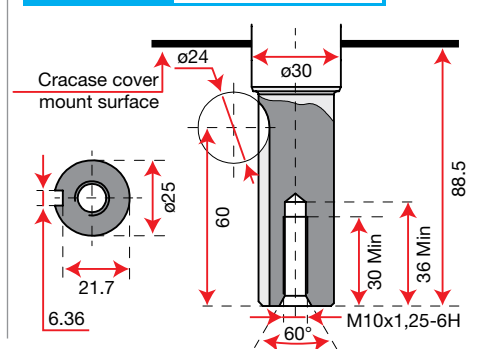

Technical data

Net power	6.7 HP - 4.9 kW / 3600 rpm
Net torque	15.5 N.m / 2400 rpm
Bore x Stroke	78 mm x 73 mm
Displacement	349 cc
Starting	Recoil start Recoil start / electric*
Fuel capacity	3.5 L
Oil capacity	1.1 L
Dimension	390 x 430 x 460 mm
Net weight	39 kg 44 kg*

* electric version (Engine p/n 3175000)

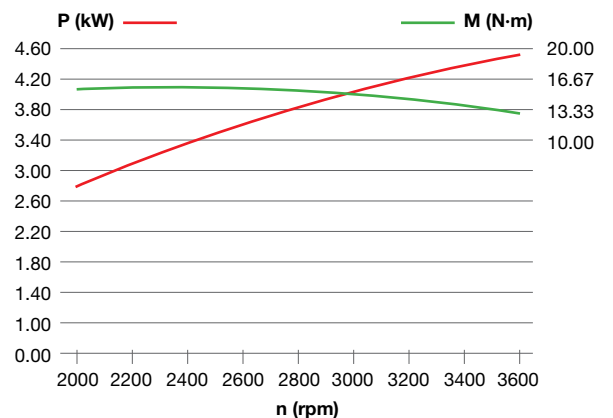

Agricultural engines line

K 9000 HD



Dimensions

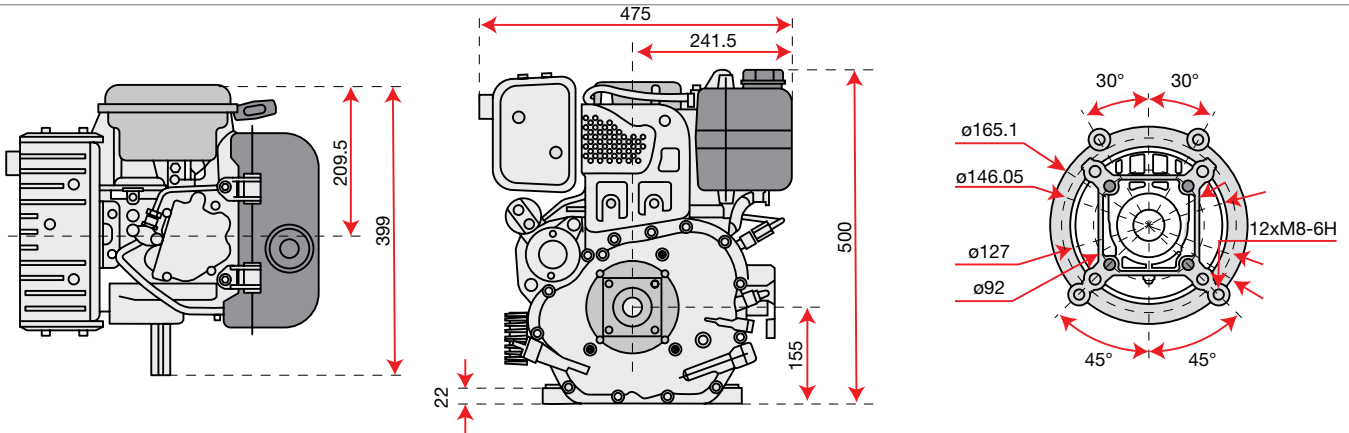

Engine p/n 3175041

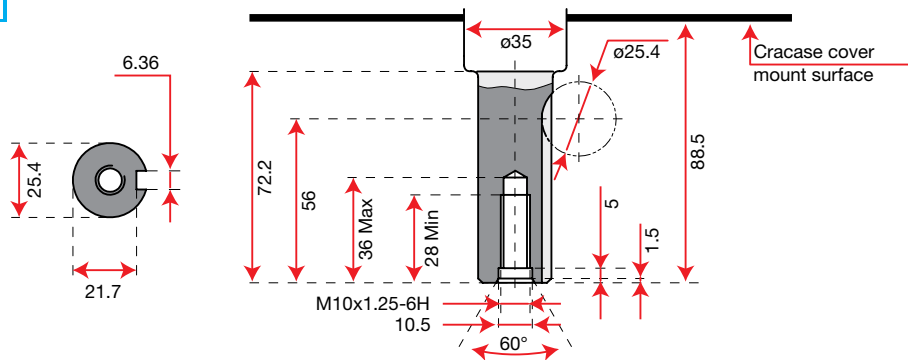

Technical data

Net power	9.2 HP - 6.8 kW / 3600 rpm
Net torque	22 N.m / 2400 rpm
Bore x Stroke	86 mm x 76 mm
Displacement	441 cc
Starting	Recoil start / electric
Fuel capacity	4.5 L
Oil capacity	1.6 L
Dimension	399 x 475 x 500 mm
Net weight	51 kg

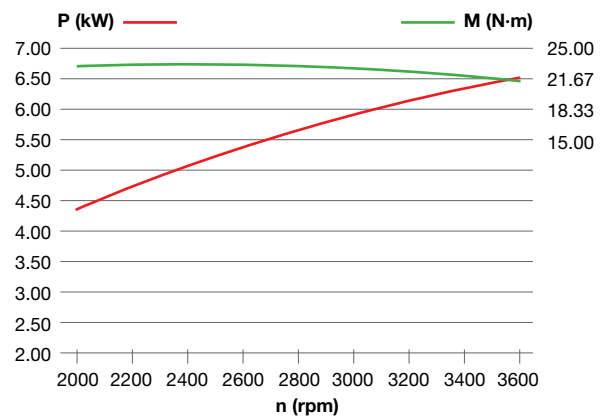

Emak Gardening Engines Line,
easy to start, reliable and available
in different configurations.



ENGINE LINE-UP



K 450

K 605

K 655
K 655 HF

K 655 i

K 805

K 1250

K 1450

K 1600

K 2400

Emak Engines Gardening Line

Vertical shaft engines are available in different displacements for every needs. Main features like, easy to start, easy to use, powerful engine selections and Stage 5 compliance, are standard on whole range.

- **Easy to start:** using the Auto-Choke technology, the starting step is always easy and ready even if outside temperature falls down.
- **Paper air filter:** wide filtering area and easy to clean, protecting and ensuring long life to the engine.
- **Ergonomic design:** compact engine and cutting-edge design, perfect combination to avoid any interference with hedges or small trees.
- **Full compatibility:** these light and compact engines, available in different displacements can be fixed upon various cutting decks.
- **Easy to maintain:** cleaning the main parts (air filter, sparking plug, starter pulley etc.) and also refilling or change the oil are very quick and fast due to the engine construction layout.



Stage 5
Low emission engines, compliant with European emission standards (STAGE 5).



OHV technology
Overhead valve (OHV) engine is a piston engine whose valves are located in the cylinder head above the combustion chamber. Perfect and stable performance also during heavy use.



Auto Choke
A device attached to the carburettor that automatically reduces the amount of air entering the carburettor by sensing changes in engine temperature.



iK-GO
Emak engine with electric starter running on a rechargeable battery.



Gasoline
Gasoline fuel type engine.



Electric starter
Engine with electric starter device.

Gardening engines line

K 450



Dimensions

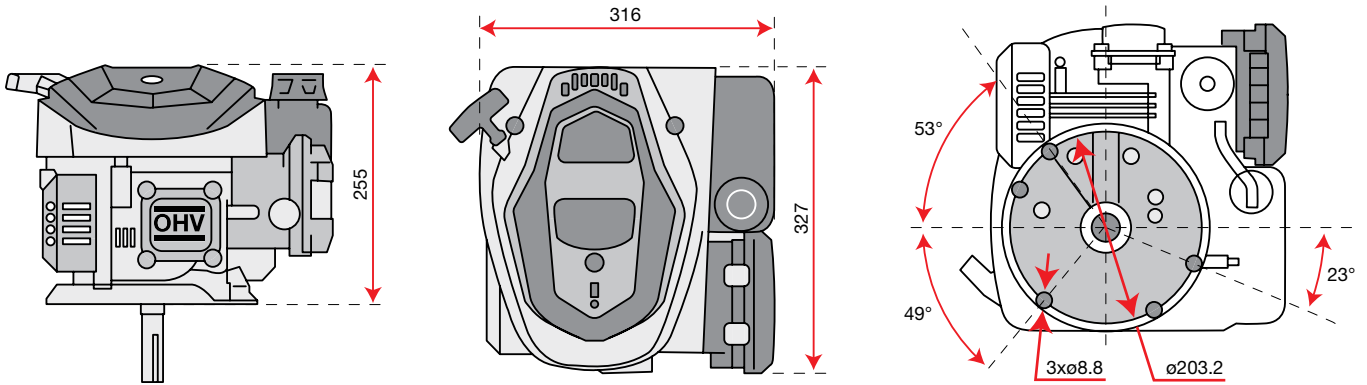

Engine p/n 3075284

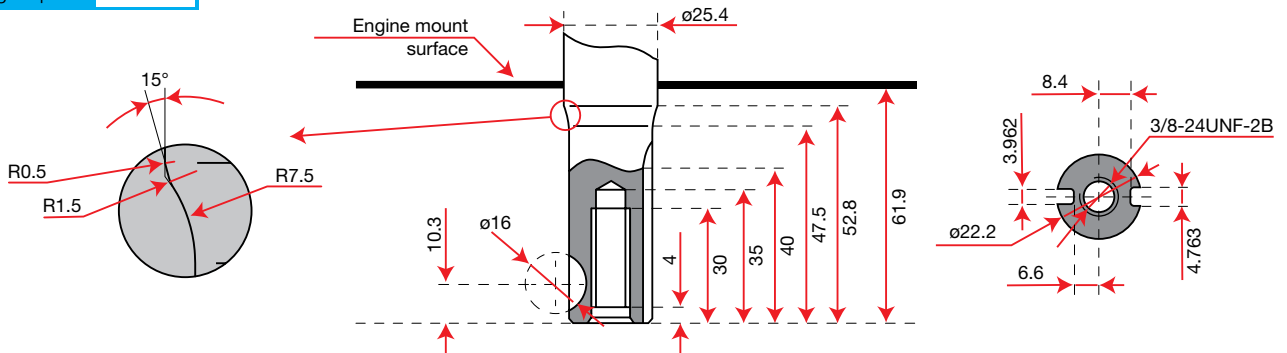

Technical data

Net power	2.8 HP - 2.1 kW / 3600 rpm
Net torque	6.5 N.m / 2500 rpm
Bore x Stroke	65 mm x 37 mm
Displacement	123 cc
Starting	Recoil start
Fuel capacity	0.9 L
Oil capacity	0.5 L
Dimension	385 x 340 x 267 mm
Net weight	8.5 kg

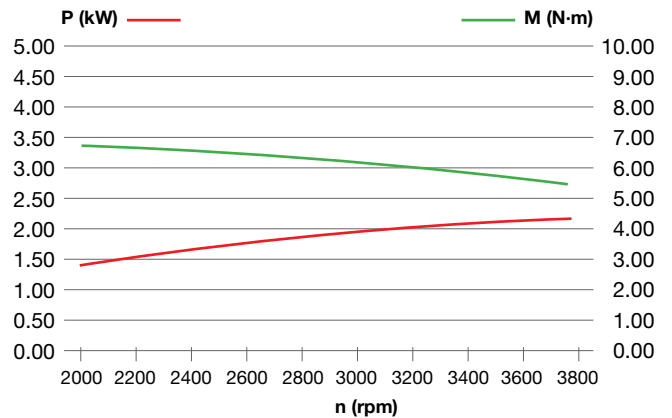

Gardening engines line

K 605



Dimensions

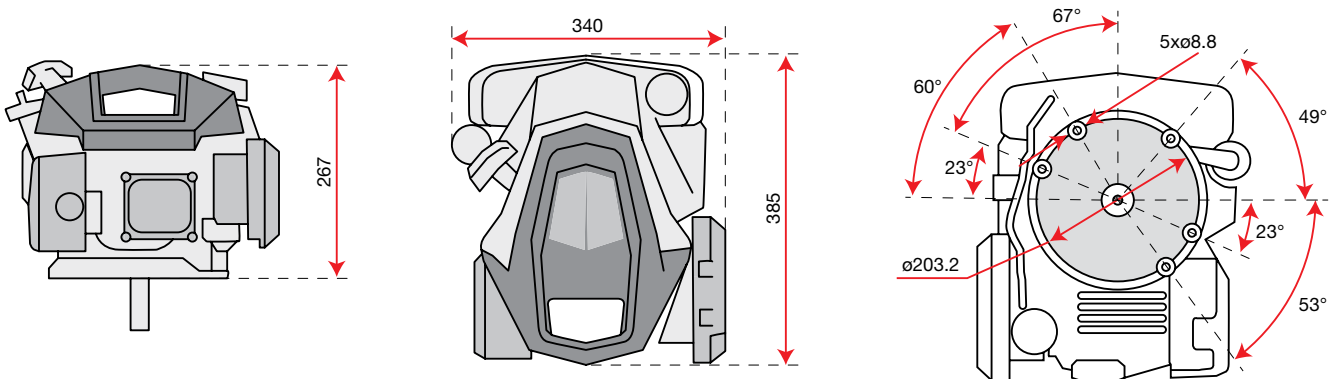

Engine p/n 3075264

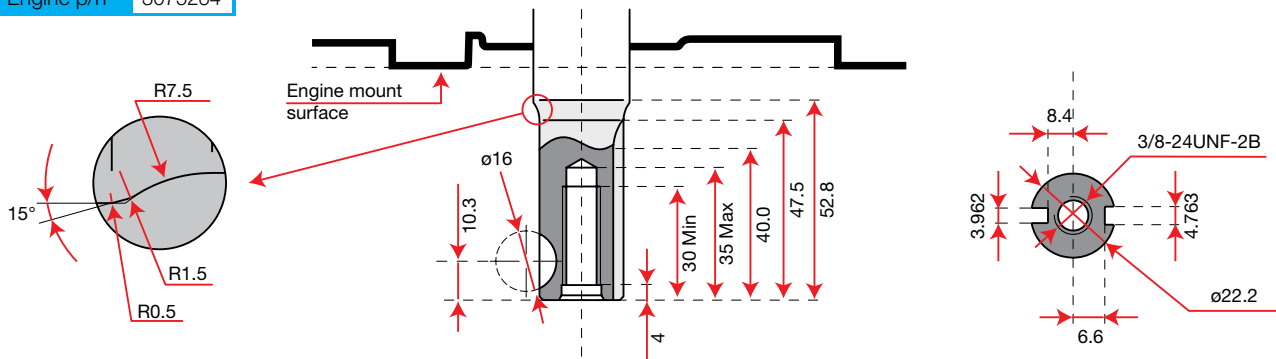

Technical data

Net power	3.3 HP - 2.4 kW / 3600 rpm
Net torque	7.5 N.m / 2500 rpm
Bore x Stroke	65 mm x 42 mm
Displacement	139 cc
Starting	Recoil start
Fuel capacity	1.4 L
Oil capacity	0.5 L
Dimension	385 x 340 x 267 mm
Net weight	9.2 kg

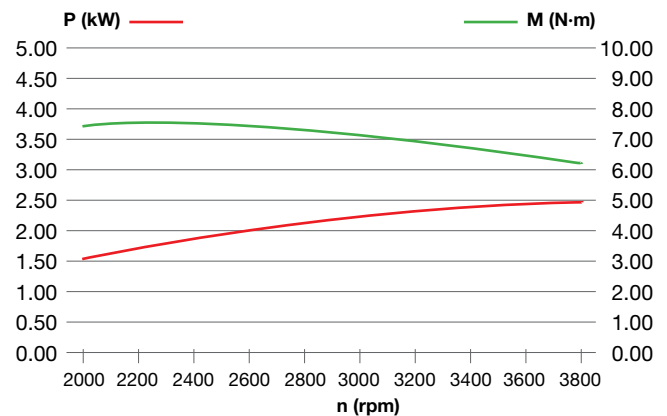

Gardening engines line

K 655



Dimensions

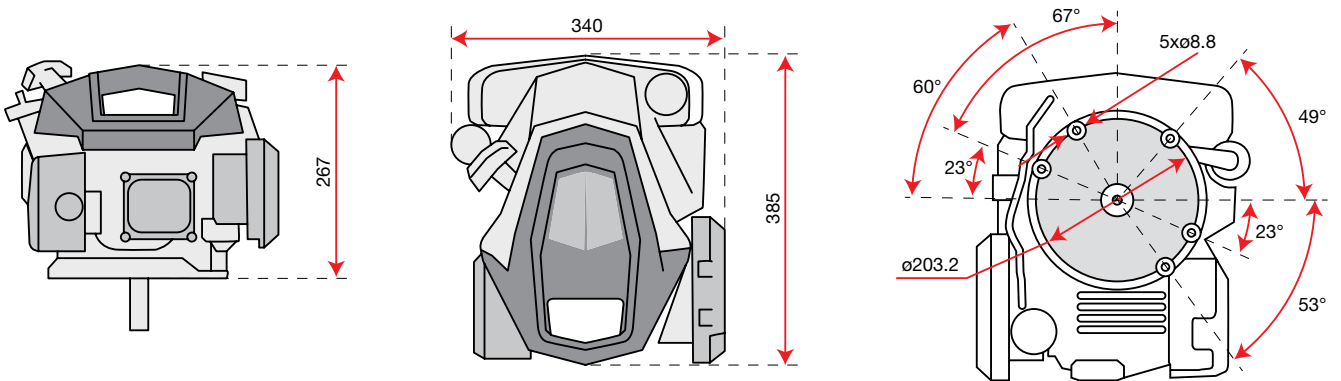

Engine p/n 3075265

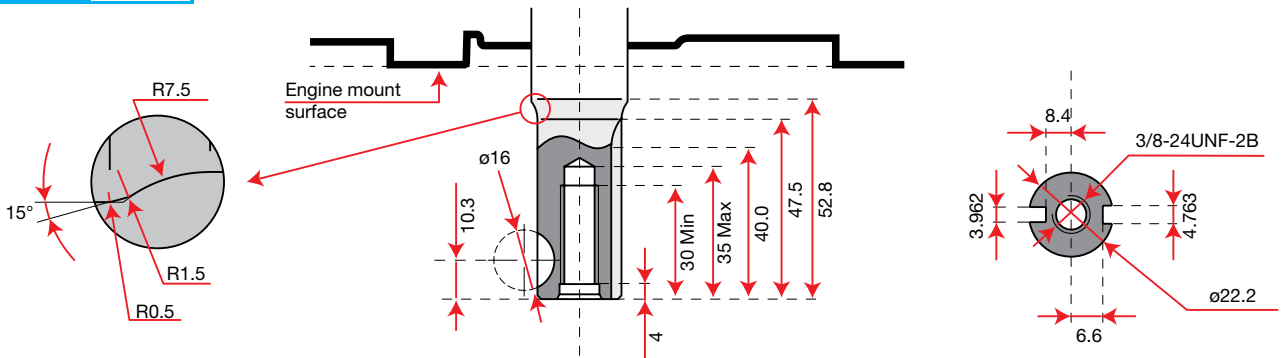

Technical data

Net power	3.9 HP - 2.9 kW / 3600 rpm
Net torque	9.5 N.m / 2500 rpm
Bore x Stroke	65 mm x 50 mm
Displacement	166 cc
Starting	Recoil start
Fuel capacity	1.4 L
Oil capacity	0.5 L
Dimension	385 x 340 x 267 mm
Net weight	9.2 kg

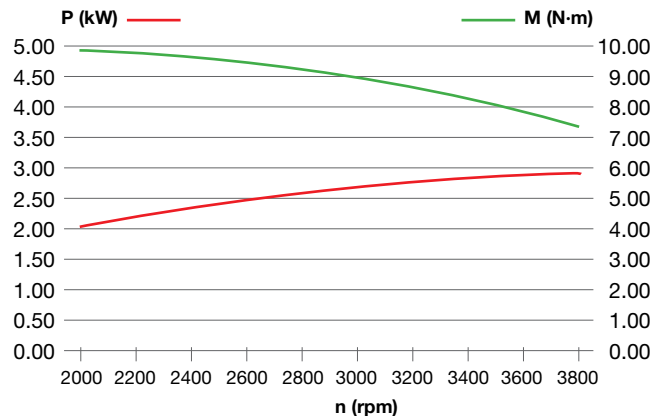

Gardening engines line

K 655 HF



Dimensions

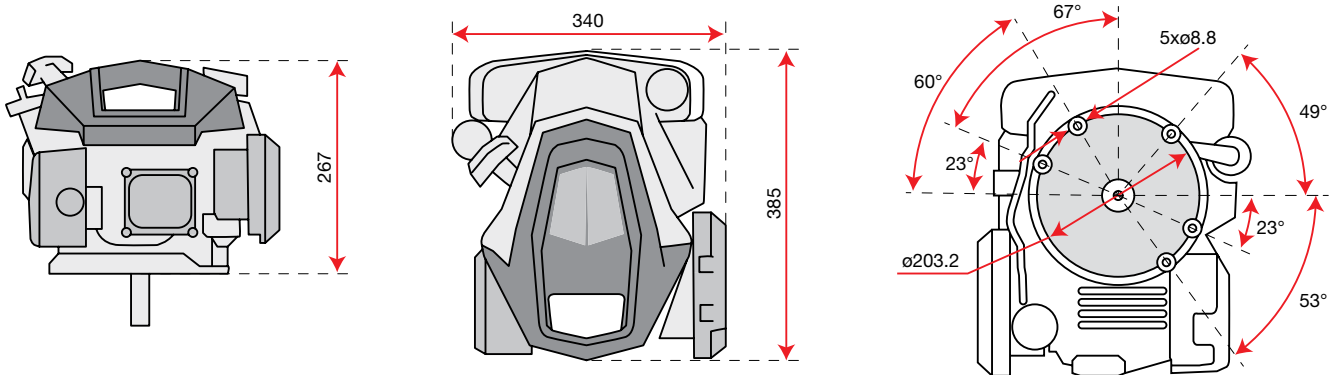

Engine p/n 3075270

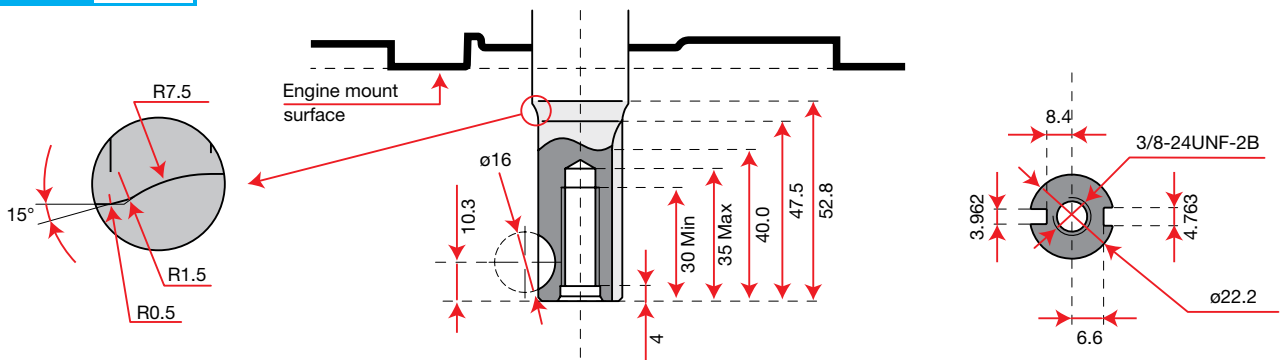

Technical data

Net power	3.9 HP - 2.9 kW / 3600 rpm
Net torque	9.5 N.m / 2500 rpm
Bore x Stroke	65 mm x 50 mm
Displacement	166 cc
Starting	Recoil start
Fuel capacity	1.4 L
Oil capacity	0.5 L
Dimension	385 x 340 x 267 mm
Net weight	10.5 kg

Notes: engine with heavy flywheel, suitable for applications where a higher moment of inertia is needed

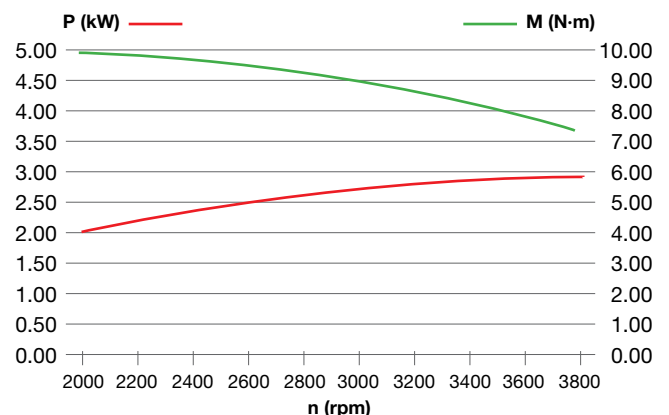

Gardening engines line

K 655 i



Dimensions

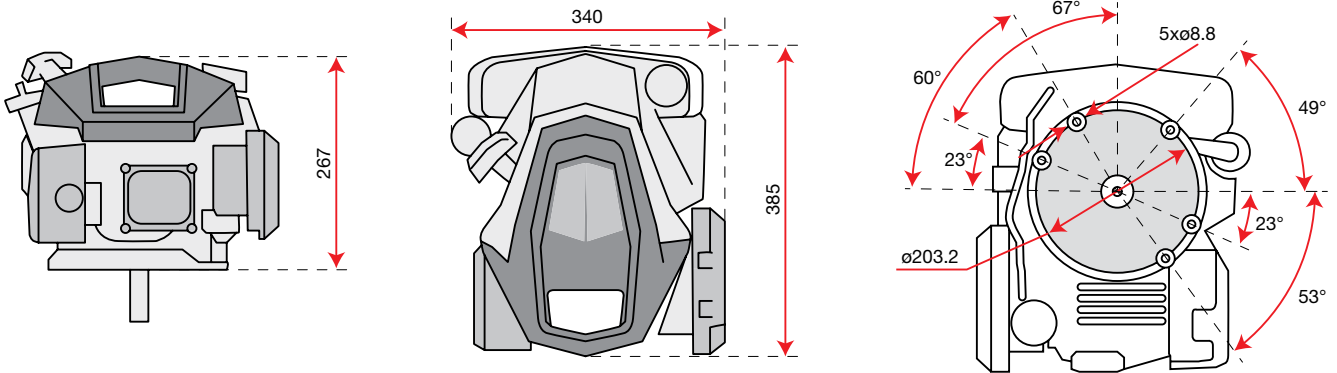

Engine p/n 3075271

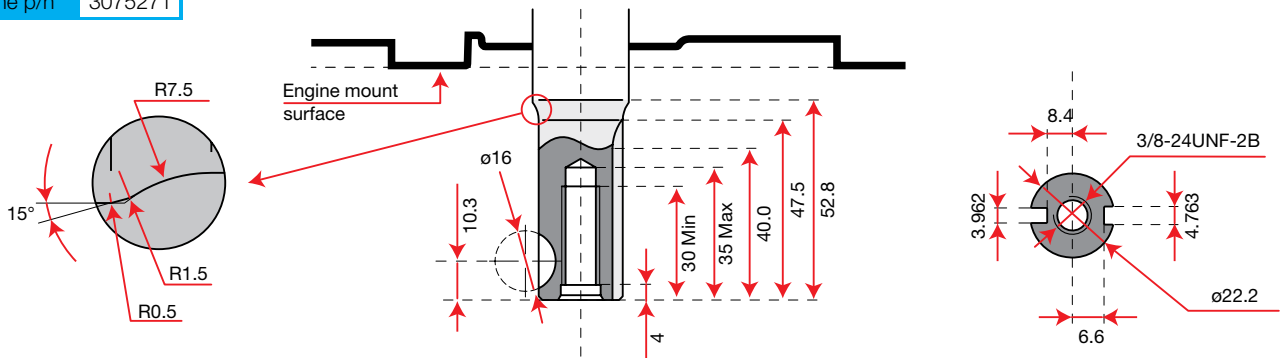

Technical data

Net power	3.9 HP - 2.9 kW / 3600 rpm
Net torque	9.5 N.m / 2500 rpm
Bore x Stroke	65 mm x 50 mm
Displacement	166 cc
Starting	Recoil start / electric
Fuel capacity	1.4 L
Oil capacity	0.5 L
Dimension	385 x 340 x 267 mm
Net weight	10.7 kg

Optional: battery (p/n 3075272R) and battery charger (p/n 3075273R)

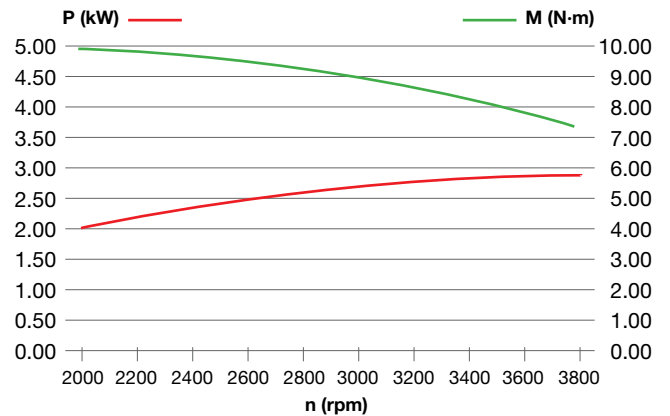

Gardening engines line

K 805



Dimensions

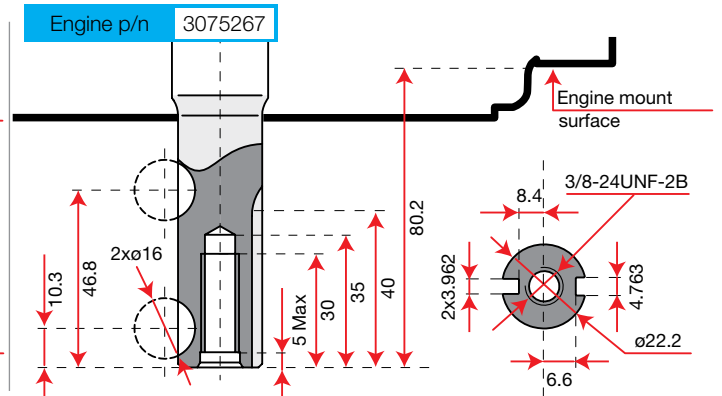
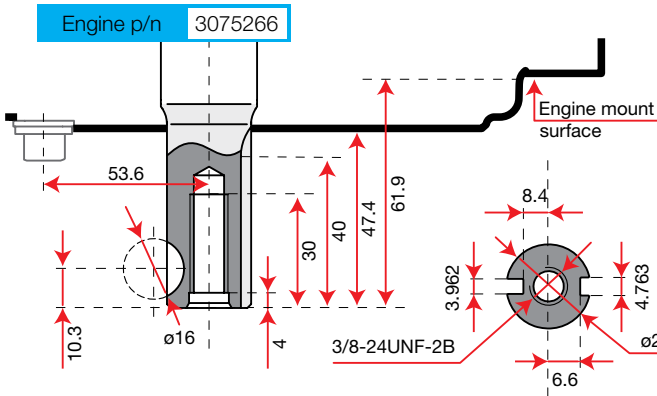
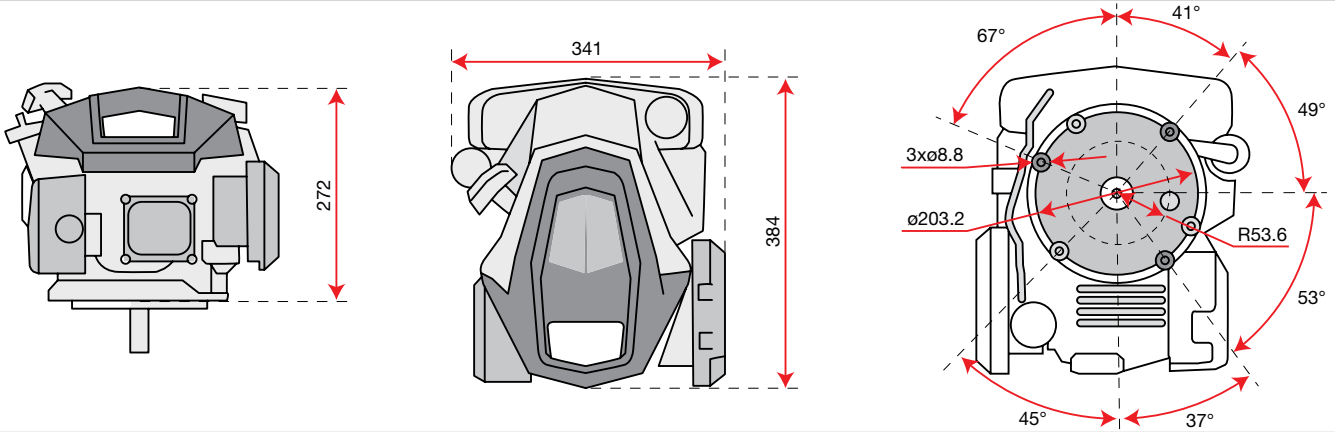

Technical data

Net power	5.4 HP - 4.0 kW / 3600 rpm
Net torque	12 N.m / 2500 rpm
Bore x Stroke	70 mm x 50.84 mm
Displacement	196 cc
Starting	Recoil start
Fuel capacity	1.4 L
Oil capacity	0.5 L
Dimension	384 x 341 x 272 mm
Net weight	12.8 kg

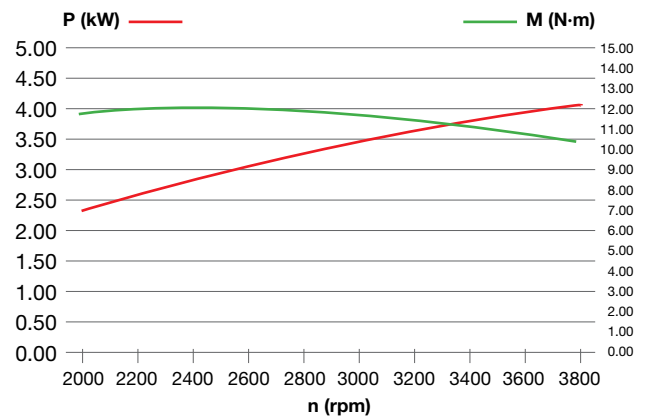

Gardening engines line

K 1250



Dimensions

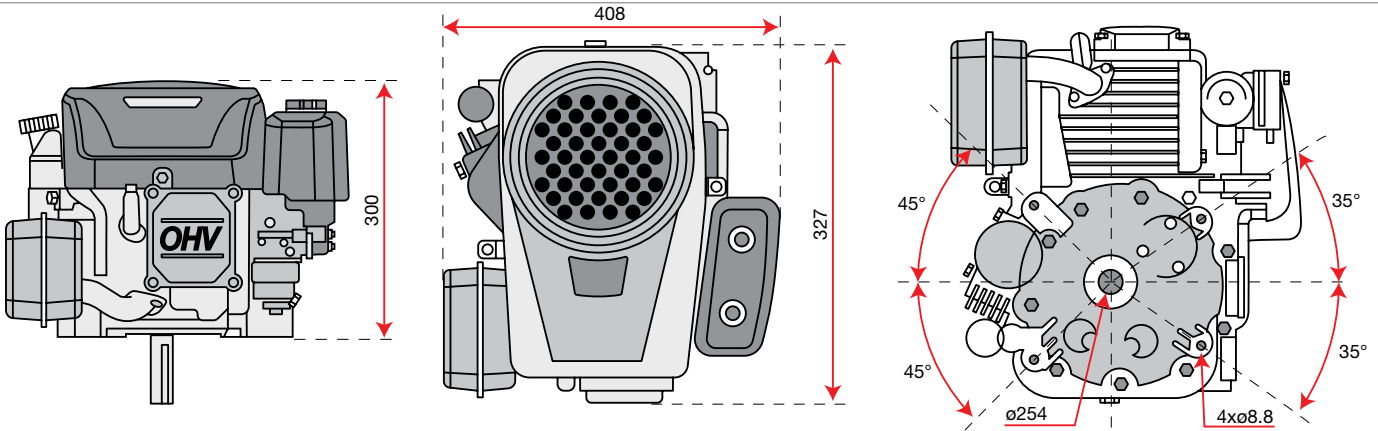

Engine p/n 3075268

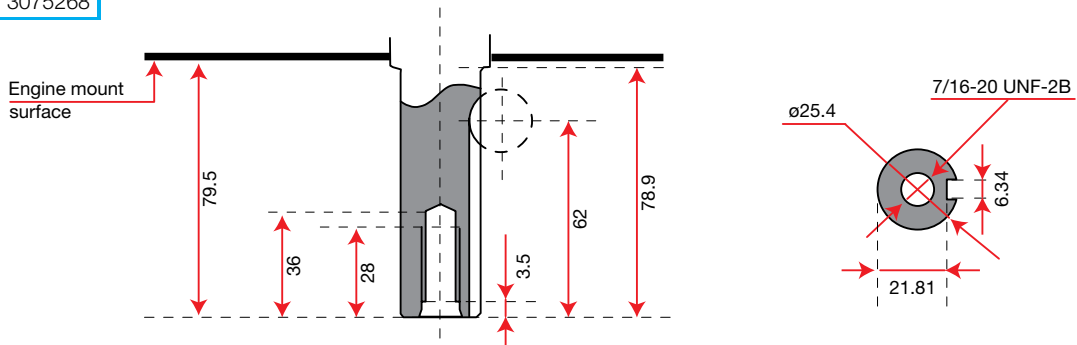

Technical data

Net power	11.7 HP - 8.6 kW / 3600 rpm
Net torque	22 N.m / 2600 rpm
Bore x Stroke	88 mm x 68 mm
Displacement	413 cc
Starting	Electric
Fuel capacity	Not available
Oil capacity	1.2 L
Dimension	432 x 408 x 300 mm
Net weight	31 kg

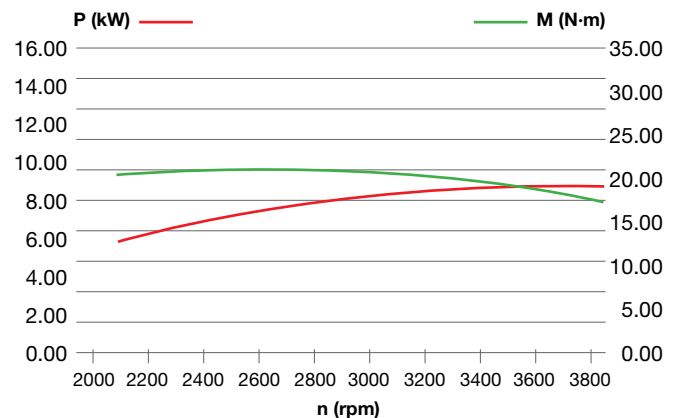

Gardening engines line

K 1450



Dimensions

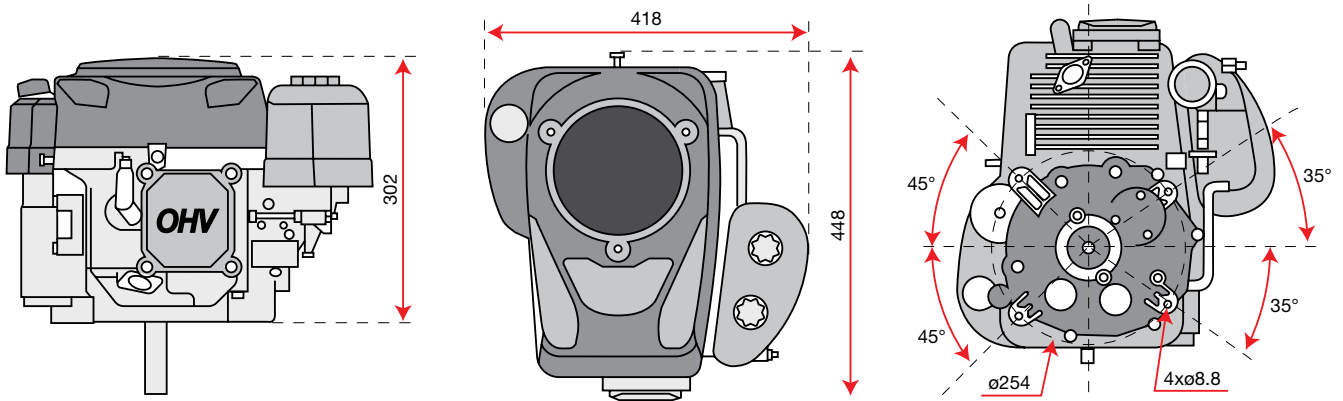

Engine p/n 3075285

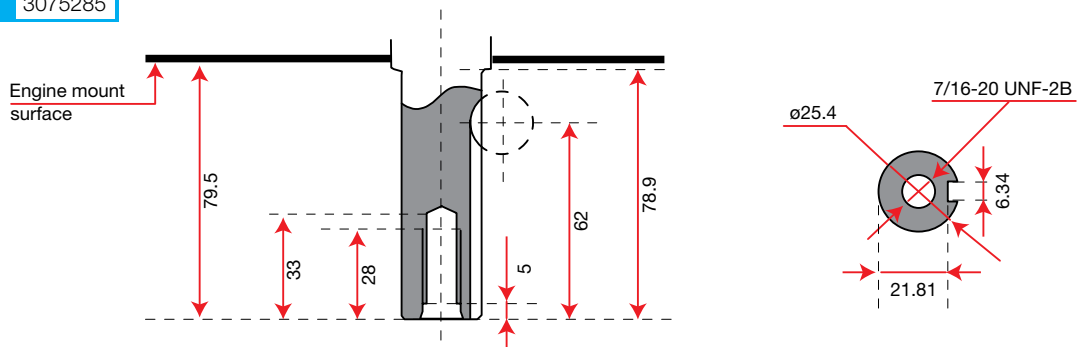

Technical data

Net power	12 HP - 8.8 kW / 3600 rpm
Net torque	24 N.m / 2600 rpm
Bore x Stroke	90 mm x 68 mm
Displacement	432 cc
Starting	Electric
Fuel capacity	Not available
Oil capacity	1.2 L
Dimension	448 x 418 x 302 mm
Net weight	32.5 kg

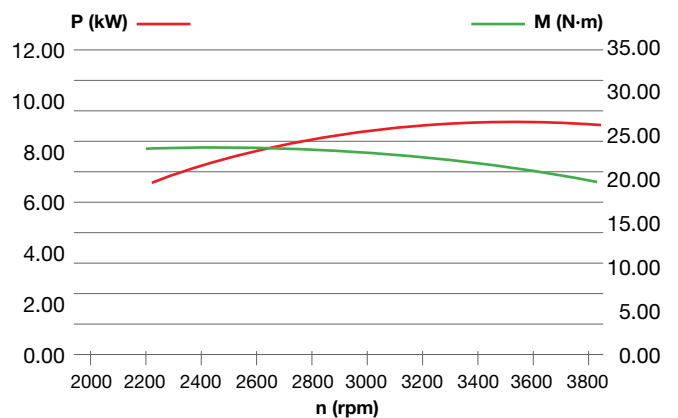

Gardening engines line

K 1600



Dimensions

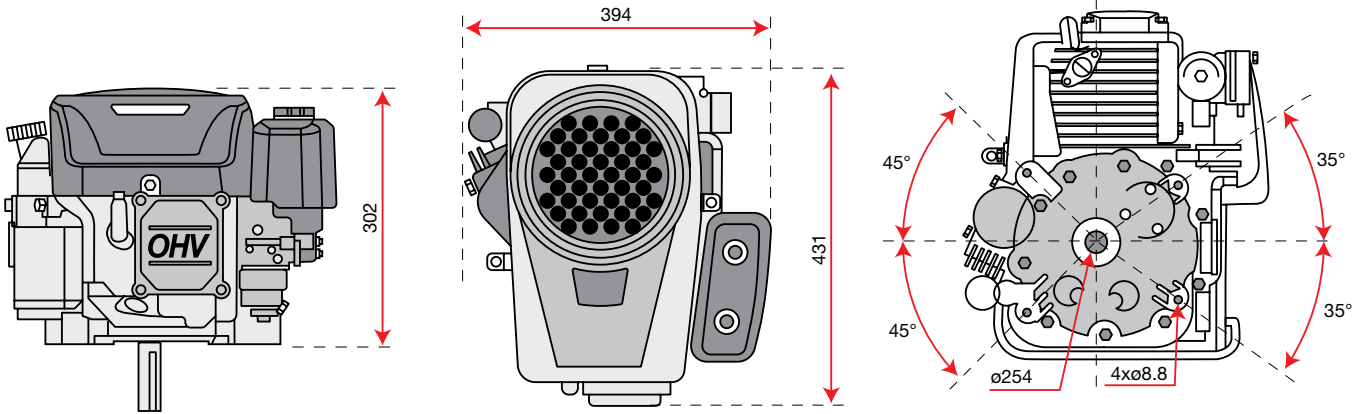

Engine p/n 3075286

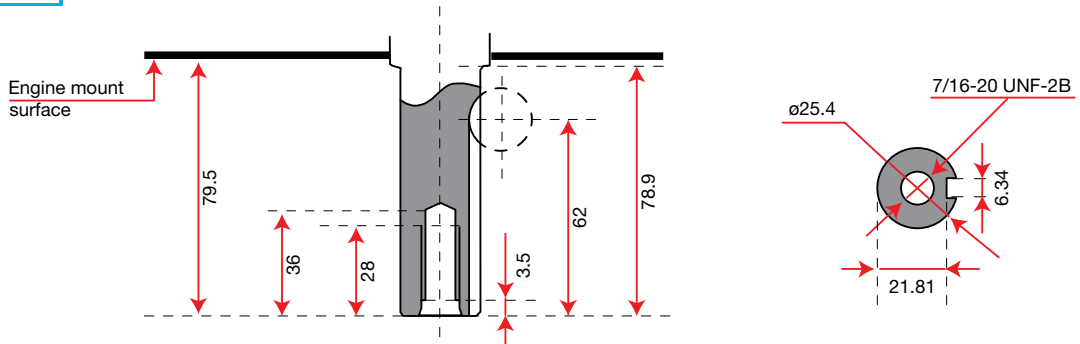

Technical data

Net power	12.5 HP - 9.2 kW / 3600 rpm
Net torque	27 N.m / 2600 rpm
Bore x Stroke	92 mm x 68 mm
Displacement	452 cc
Starting	Electric
Fuel capacity	Not available
Oil capacity	1.2 L
Dimension	432 x 294 x 302 mm
Net weight	31 kg

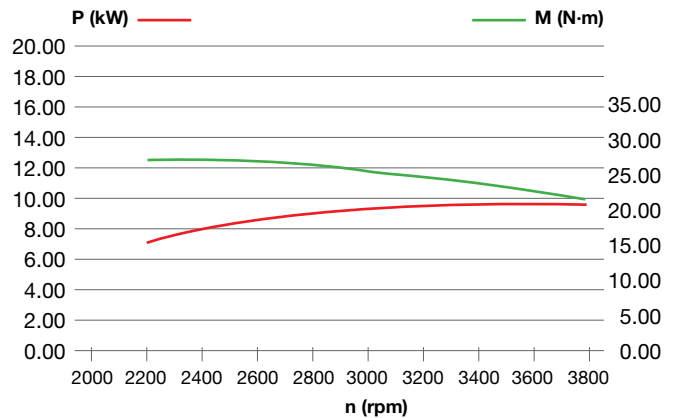

Gardening engines line

K 2400



Dimensions

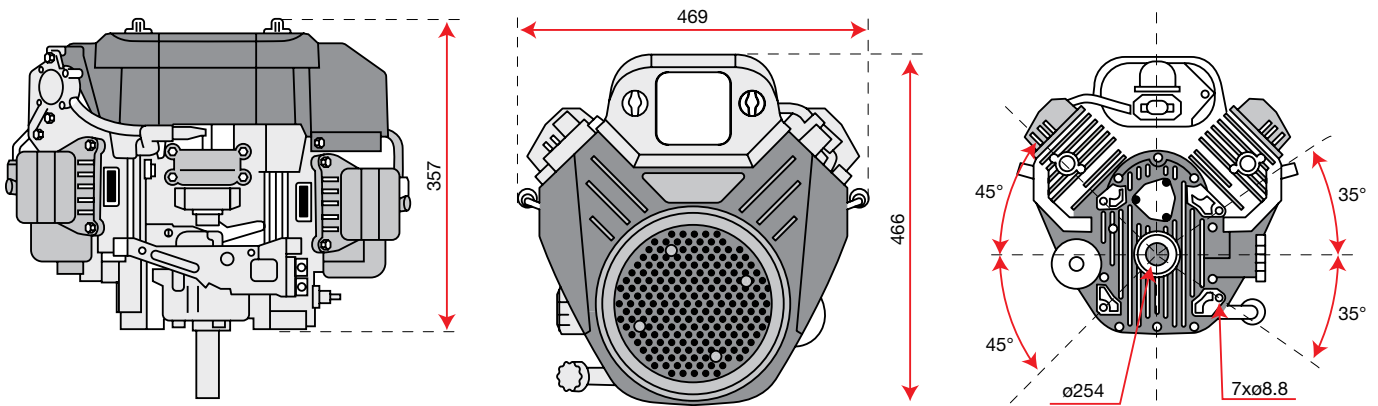

Engine p/n 3075288

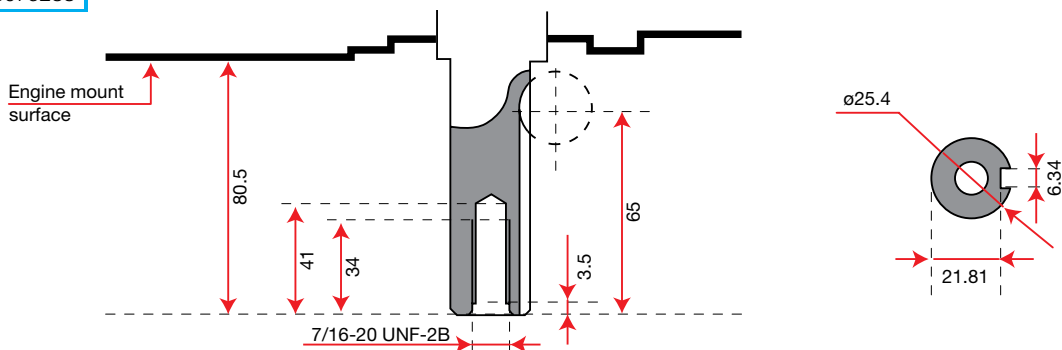

Technical data

Net power	21.7 HP - 16 kW / 3600 rpm
Net torque	47.5 N.m / 2400 rpm
Bore x Stroke	77 mm x 76 mm
Displacement	708 cc
Starting	Electric
Fuel capacity	Not available
Oil capacity	1.8 L
Dimension	466 x 469 x 357 mm
Net weight	43 kg

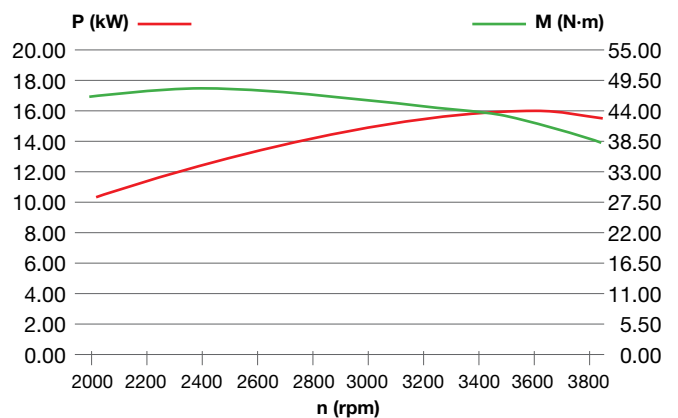

General warnings

Data and illustrations published in the catalogue are not binding where specifications of materials are concerned, given that these will always be subject to technical improvement. Technical specifications given in the catalogue are subject to change without notice, as also are directions relating to general use of the equipment.

Engine power data refers to the values declared by each manufacturer. These values are calculated in accordance with specific measurement standards (such as SAE J1940, SAE J1349, ISO 1585) and may be modified without prior notice.

Certain items are not available in all countries, or are available only on request.



B

E

Subject to modifications. Some models are available for certain markets only. - Cod. 3185002Q - 2023



It's an **Emak S.p.A.** trademark
42011 Bagnolo in Piano (RE) Italy
mybertolini.com

